

Azienda Our company



Il brand Sartoris nasce da un'ambiziosa sfida: elevare il divano letto, troppo a lungo considerato come mero arredo di servizio, ad autentico oggetto di design in cui estetica e funzionalità possano trovare piena realizzazione, in un ideale connubio.

Per intraprendere questo percorso non siamo partiti da zero ma dal bagaglio pluridecennale di esperienza e successi della nostra casa madre.

Max Divani è infatti da sempre specializzata nella produzione di divani artigianali, espressione di quella pregevolezza e cura per il dettaglio che solo il migliore Made in Italy può assicurare.

E lo abbiamo fatto restando con i piedi saldi nella nostra terra, la Murgia altamurana, ormai da decenni consacrata a distretto del mobile imbottito, cuore pulsante di una produzione animata innanzitutto dalla passione e dal desiderio di fare sempre meglio.

Si sviluppa così la collezione Sartoris: forte di una consolidata squadra di professionisti e dei valori di tenacia e lungimiranza consegnati in eredità da Mimmo Ferri, ideatore del brand, alla terza generazione di imprenditori Max Divani. Grazie alla visione e all'intraprendenza di questi ultimi, Sartoris si propone come un progetto imprenditoriale al passo con le esigenze della vita contemporanea e pronto ad assecondare un mercato in costante evoluzione.



The Sartoris brand was born from an ambitious challenge: upgrade the sofa bed, which has been considered a mere piece of furniture for too long, to an authentic interior design item which fully embraces aesthetics and functionality, in a perfect match.

For this journey we did not start from scratch, but from the decades of experience and success of our parent company.

Max Divani has always specialised in the production of handcrafted sofas, an expression of that quality and attention to detail that only the best Made in Italy can ensure.

And we kept our feet firmly in our land, the Murgia Altamurana, the district of upholstered furniture for decades, the beating heart of a production animated above all by passion and the desire to always do better.

This is how the Sartoris collection develops: thanks to a consolidated team of professionals and the values of tenacity and foresight handed down as a legacy by Mimmo Ferri, creator of the brand, to the third generation of Max Divani entrepreneurs. Thanks to the vision and resourcefulness of the latter, Sartoris presents itself as an entrepreneurial project in step with the needs of contemporary life and ready to accommodate a constantly evolving market.

Sarti del divano Sofa couturies



Nato come arredo relegato in un ambiente secondario dell'abitazione, da usare all'occorrenza, il divano letto della collezione Sartoris esce dalla camera degli ospiti per conquistarsi il meritato ruolo di protagonista della zona living.

Il design ricercato, dall'alta resa estetica, e la cura dei dettagli a tutto tondo lo rendono un salotto che ama farsi collocare a centro stanza, diventando il cuore della vita domestica a tutte le ore del giorno e anche della notte.

Ogni modello nasconde infatti una doppia attitudine, che si esprime nella trasformazione in accogliente letto matrimoniale, al quale passare in un attimo grazie a pochi e intuitivi passaggi.

I divani Sartoris sono però così belli che è possibile richiederli anche senza l'opzione letto, godendone semplicemente come salotto intorno al quale vivere i propri momenti di convivialità e relax.

Born as a piece of furniture relegated to a secondary room of a house, to be used when needed, the sofa bed from the Sartoris collection comes out of the guest room to earn its deserved role as the protagonist of the living area.

Its refined design, with a high aesthetic yield, and the attention to detail, make it a sofa that loves to stay in the centre of the room, becoming the heart of domestic life at all hours of the day and night.

In fact, each model hides a dual aptitude, which is expressed in the transformation into a welcoming double bed, which can be changed in an instant thanks to a few easy steps.

Sartoris sofas are so beautiful, however, that also models without the bed option are available, to simply enjoy them as a sofa around which to live your moments of conviviality and relaxation.

Ripensare al divano letto Rethinking the sofa bed



Quello che abbiamo ereditato da Max Divani è la cura sartoriale che riponiamo in ogni dettaglio e in ogni passaggio produttivo dei nostri divani: dalla progettazione alle ultime finiture. Il risultato è un prodotto in cui il pregio estetico è il riflesso diretto della qualità e della ricercatezza di ogni singolo materiale e componente.

I divani della collezione Sartoris, distanti da qualsiasi produzione "in serie", sono infatti tutti personalizzabili, in ogni aspetto: configurazioni, dimensioni, rivestimenti – per i quali è possibile scegliere tra pelle e innumerevoli varianti di tessuto, sempre di grande pregio – e finiture decorative.

Inoltre, per assecondare al meglio ogni idea di riposo, è possibile scegliere per il letto la tipologia di materasso che si predilige: dalle densità di base a quelle più portanti, senza tralasciare il memory e il materasso in biopolimeri. In più, in base al modello, oltre alla classica rete ortopedica è disponibile anche l'opzione con doghe in legno.

Il risultato sarà un divano facilmente collocabile in qualsiasi ambiente e compatibile con ogni tipo di arredamento. Il tutto con un'anima soffice e pronta ad accogliere al bisogno un ottimo sonno ristoratore.

What we have inherited from Max Divani is the sartorial care that we put into every detail and every production step of our sofas: from design to the final finishing touches. The result is a product in which the aesthetic value is the direct reflection of the quality and refinement of each individual material and component.

The sofas of the Sartoris collection, very different from any "mass" produced ones, are in fact all customisable, in every aspect: shapes, dimensions, coverings - for which it is possible to choose between leather and countless fabric variations, always of great value - and decorative finishes.

Furthermore, to best accommodate every type of rest, it is possible to choose the type of mattress for the bed: from basic densities to the most supporting ones, without forgetting memory and the biopolymer mattresses. Furthermore, depending on the model, in addition to the classic orthopedic base, the option with wooden slats is also available.

The result will be a sofa that can be easily placed in any environment and compatible with any type of furniture. They are all extremely soft and ready to welcome an excellent restful sleep when needed.

SOFA BEDS COLLECTION



Aurora
06 - 17



Penelope
18 - 29



Nathan
30 - 45



Evelyn
136 - 141



Flora
142 - 149



Freddy
150 - 155



Paul
46 - 59



Perry
60 - 69



Elodie
70 - 75



George
156 - 161



Laurence
162 - 167



Moon
168 - 175



Eudora
76 - 83



Amelia
84 - 93



Maya
94 - 99



Naomy
176 - 181



Violet
182 - 187



Loll
188 - 195



Henry
100 - 105



Isobel
106 - 111



Matilda
112 - 117



Jason
196 - 201



Otto
202 - 207



Byblos
208 - 213



Emily
118 - 123



Meryl
124 - 129



Dandy
130 - 135



Poltrone
214 - 219



Complementi
220 - 231

Info Tecniche
232 - 269

Aurora

Espressione allo stesso tempo di artigianalità e design contemporaneo, il modello trasformabile Aurora è un capolavoro d'arte sartoriale da esporre in salotto o nel living. Suo punto di forza è sicuramente il bracciolo con struttura in metallo a vista, fasciato in un rivestimento imbottito e rifinito con cuciture trapuntate. Più ricercato nella versione con dettagli in pelle pura anilina color cognac o più casual in quella completamente in tessuto tecnico idrorepellente, questo divano unisce l'estetica e il comfort all'immediatezza dell'uso. Facile e veloce è infatti l'apertura del divano letto: basterà ribaltare lo schienale per svelare un piano di riposo immediatamente pronto ad accogliere lenzuola e guanciali.

An expression of craftsmanship and contemporary design at the same time, the Aurora convertible model is a masterpiece of sartorial art to be displayed in the living room. Its strong point is certainly its armrest with visible metal structure, wrapped in a padded covering and finished with quilted stitching. More refined in the version with details in pure aniline cognac-colored leather or more casual in the one completely in water-repellent technical fabric, this sofa combines aesthetics and comfort with immediacy of use. In fact, the opening of the sofa bed is quick and easy: just fold down the backrest to reveal a resting surface immediately ready to accommodate sheets and pillows.











*mod. Aurora
v. 325 - 246
H. mattress 13 cm*





*mod. Aurora
v. 324
H. mattress 13 cm*



Aurora

Penelope

Maestria e sapienza artigianali sono in questo divano letto al servizio della funzionalità e del buon riposo. Reso unico dalla particolare imbottitura con impunture a fasce orizzontali dei braccioli, Penelope è un modello che, per il suo alto impatto estetico, è stato pensato per essere posizionato anche a centro stanza. Inoltre, la possibilità di personalizzarne le dimensioni e di combinarlo con un modulo terminale consentono di comporre un divano perfettamente in linea con l'architettura dell'ambiente che lo accoglierà. La libertà compositiva va di pari passo con la personalizzazione dei rivestimenti, proposti nell'abbinamento di pelle e tessuto o completamente in tessuto, con dettagli sartoriali a contrasto.

In this sofa bed, craftsmanship and artisanal knowledge are at the service of functionality and good rest. Made unique by its particular padding with horizontal band stitching of the armrests, Penelope is a model that, due to its high aesthetic impact, was designed to be set even in the centre of the room. Furthermore, the possibility of customizing its dimensions and combining it with a terminal module allow to compose a sofa that is perfectly in line with the architecture of the room that will welcome it. Compositional freedom goes hand in hand with the customization of the upholstery, available in a combination of leather and fabric or completely in fabric, with contrasting sartorial details.







*mod. Penelope
v. 324
H. mattress 13 cm*





mod. Penelope
v. 230 - 305
v. 324





Nathan

Nel modello Nathan l'aspetto pratico del divano letto sempre pronto all'uso convive alla perfezione con la ricercatezza del design. Proposto nella versione base di divano a tre sedute, attraverso l'abbinamento di moduli in forme e dimensioni diverse, si presta a configurazioni sempre nuove, per adattarsi al meglio all'architettura dello spazio abitativo. Caratterizzato dalla seduta ampia e accogliente, disponibile nelle varianti liscia o trapuntata, Nathan si distingue per la spalliera composta da cuscini volanti con imbottitura in morbida piuma sintetica, che invita al riposo. I rivestimenti sono comunque personalizzabili, abbinando con versatilità pelle e tessuti, disponibili in una vasta gamma di tonalità. Particolarmente intuitivo e di semplice utilizzo è la trasformazione da divano a letto, il cui materasso risulta dalla giustapposizione delle parti imbottite di seduta e spalliera.

In the Nathan model, the practical aspect of the sofa bed that is always ready for use coexists perfectly with the sophistication of the design. Offered in the basic version of a three-seater sofa, through the combination of modules in different shapes and sizes, it lends itself to ever new configurations, to best adapt to the architecture of the living space. Characterized by the large and welcoming seat, available in the smooth or quilted variants, Nathan stands out for its backrest composed of loose cushions with very inviting soft synthetic feather padding. The upholstery is customizable, combining with versatility leather and fabrics, available in a wide range of shades. The transformation from sofa to bed is particularly easy, with the mattress that results from the juxtaposition of the padded parts of the seat and backrest.





mod. Nathan
v. 230 - 329
v. 328







*mod. Nathan
v. 230 - 329*









mod. Nathan
v. 248 - 329



Paul

Nato dalla volontà di riscattare il classico divano letto, a lungo considerato come mero arredo di servizio, il modello Paul si candida ad essere l'indiscusso protagonista di qualsiasi ambiente in cui venga inserito. Le parti imbottite, espressione di equilibrio e misura, sono alloggiare all'interno di una solida base con rivestimento in pelle, caratterizzata da tiraggi verticali che conferiscono dinamismo e slancio all'intera struttura. Modello versatile, nasce come divano a tre posti ma può essere pensato anche come scenografica composizione angolare. Collocato su slitta metallica disponibile in quattro diverse finiture, Paul si trasforma, in un solo gesto e senza dover rimuovere le spalliere, in un accogliente letto matrimoniale: sarà sufficiente tirare la cinghia in pelle agganciata dietro lo schienale e attivare così il meccanismo a ribalta.

Born from the desire to upgrade the classic sofa bed, long considered a mere utility piece of furniture, the Paul model is a candidate to be the undisputed protagonist of any environment in which it is placed. The padded parts, an expression of balance and measure, are housed inside a solid base with leather upholstery, characterized by vertical draw cords that give dynamism and momentum to the entire structure. A versatile model, it was born as a three-seater sofa but can also be thought of as a scenic corner composition. Placed on a metal sled base available in four different finishes, Paul transforms, in a single movement and without the need to remove the backrests, into a welcoming double bed: simply pull the leather strap hooked behind the backrest and thus activate the folding mechanism.







*mod. Paul
v. 324
H. mattress 16 cm*



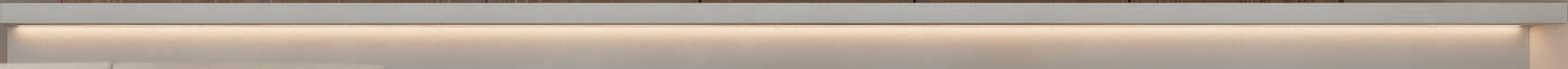



mod. Paul
v. 330 - 407 - 309
H. mattress 16 cm



Paul





Perry

Il modello Perry, curato artigianalmente nei minimi particolari e adatto ad essere posizionato anche a centro stanza, reinterpreta il tradizionale divano letto grazie ad uno stile mai banale. Di grande impatto estetico, si caratterizza per il profilo arrotondato del bracciolo, sospeso e staccato da terra in un motivo che ritorna lungo tutto il perimetro della base, conferendo leggerezza all'intera struttura. Come tutti i modelli della linea Sartoris, anche Perry si distingue per la pregevolezza dei dettagli sartoriali, espressi nel rivestimento in tessuto di fibre naturali e nei cuscini volanti che ne compongono la spalliera. Per concedersi un sonno ristoratore sarà possibile attivare la meccanica a ribalta e svelare così il piano di riposo, su cui abbiamo collocato un confortevole materasso da sedici centimetri di altezza.

The Perry model, handcrafted in the smallest details and suitable for being positioned even in the centre of the room, reinterprets the traditional sofa bed thanks to a style that is never banal. Of great aesthetic impact, it is characterised by the rounded profile of the armrest, suspended and detached from the ground in a motif that returns along the entire perimeter of the base, rendering the entire structure lighter. Like all the models in the Sartoris line, Perry also stands out for the quality of its sartorial details, expressed in the natural fibre fabric covering and in the loose cushions that make up the backrest. To enjoy a restful sleep, the folding mechanism can be activated to reveal the sleeping surface, on which we have placed a comfortable sixteen-centimetre high mattress.







*mod. Perry
v. 324
H. mattress 13 cm*







mod. Perry
v. 326 - 245
H. mattress 13 cm



Elodie

Moderno e versatile divano da salotto tre posti con un unico cuscino di seduta, il modello Elodie svela all'occasione un'inaspettata seconda anima come letto matrimoniale. Essenziale nel design e sintesi di un equilibrato gioco di volumi, questo modello esprime ricercatezza mettendosi al contempo al servizio del riposo, sia che si tratti di una piccola pausa di relax durante la giornata, sia nel caso si cerchi un sonno ristoratore. Espressione di pura artigianalità Made in Italy è la cura sartoriale che abbiamo dedicato ad ogni suo dettaglio: dal rivestimento in tessuto sfoderabile bouclé color avio, con impunture sulla seduta e sulla superficie laterale dei braccioli, fino alle cuciture pizzicate che con carattere ne definiscono i volumi. Come in tutti i modelli della linea Sartoris, anche per Elodie – semplicemente tirando la cinghia in pelle integrata – è possibile azionare in pochi attimi il meccanismo a ribalta integrato: sarà così possibile passare, in un attimo e in completa sicurezza, dalla configurazione divano a quella letto.

A modern and versatile three-seater sofa with a single seat cushion, the Elodie model unveils at the occasion an unexpected second soul as a double bed. Essential in design it is also a synthesis of a balanced play of volumes, this model reveals refinement while at the same time used to rest, whether you are looking for a little break during the day or a restful sleep. Expression of pure craftsmanship & Made in Italy is the sartorial care that we have dedicated to each detail: from the upholstery in removable avio-colored bouclé fabric, with stitching on the seat and the side surface of the armrests, to the pinched stitching that defines its character & volumes. As for all models of the Sartoris line, same applies for models Elodie – by simply pulling the integrated leather strap – it is possible to activate, the integrated flap mechanism, then to switch, in a moment & in full safety, from the static configuration to the bed configuration.







mod. Elodie
v. 324
H. mattress 16 cm



Eudora

Imponente nelle dimensioni, ma facilmente inseribile in qualsiasi contesto grazie ad un'estetica che al contempo è sobria senza essere banale, il modello tre posti maxi Eudora interpreta il divano letto con versatilità e carattere, tenendo ben presente la funzionalità. Il design si caratterizza per la spalliera volante, costituita da coppie di ampi cuscini con imbottitura in piuma d'oca e legati tra loro da una fascetta che richiama il rivestimento dei braccioli. Questi ultimi, proposti in ecopelle dal ricercato effetto nuvolato ma disponibili anche nello stesso tessuto ignifugo e smacchiabile delle parti imbottite, sono connotati lateralmente da una profonda cucitura centrale che ne esalta la profondità. Il passaggio da divano a letto avviene con pochi gesti: sarà sufficiente togliere i cuscini delle spalliere e attivare, grazie alla cinghia integrata, il meccanismo a ribalta che rivela il materasso. Eudora è stato progettato con apertura orizzontale e letto orientato trasversalmente rispetto alla seduta, così da contenere l'ingombro una volta aperto.

Imposing in size, but easy to blend into any setting thanks to its understated, yet far from mundane look, the three-seater Eudora maxi model adds a touch of versatility and character to the sofa bed, while retaining its functionality. The design features a high backrest consisting of a pair of large, goose-down-filled cushions fastened together with a strap that matches the armrest covers. These covers, made of eco-leather with an elegant cloud-like effect, but also available in the same fire-retardant and stain-resistant fabric as the upholstered elements, feature a deep central seam that highlights their depth. Switching from sofa to bed requires just a few steps: simply remove the backrest cushions and activate the lift-up mechanism by pulling on the belt provided, thus revealing the mattress. Eudora has been designed to open horizontally with the bed oriented sideways with respect to the seat, to minimize the space occupied once opened.







*mod. Eudora
v. 320
H. mattress 13 cm*





*mod. Eudora
v. 320
H. mattress 13 cm*



Eudora

Amelia

Volumi contenuti e design lineare per il divano tre posti componibili Amelia, pronto a diventare in qualsiasi momento un comodo letto matrimoniale. Di facile utilizzo – grazie al meccanismo a ribalta – e compatto nelle forme, questo modello è perfetto per essere collocato anche in ambienti contenuti: i sottili braccioli ne riducono infatti al minimo l'ingombro. Caratterizzato, sia nel bracciolo che nei cuscini volanti che fanno da spalliera, da dettagli di tessuto in contrasto cromatico, viene qui proposto in una calda tonalità color mattone. Amelia è un modello dallo spirito dinamico, componibile con chaise longue e disponibile a richiesta con rete a doghe in legno e tessuto sfoderabile.

Contained volumes and a linear design for the Amelia modular three-seater sofa, ready to become a comfortable double bed at any time. Easy to use – thanks to the fold-down mechanism – and compact in shape, this model is perfect for placing even in small spaces: the thin armrests reduce its bulk to a minimum. Characterized, both in the armrest and in the loose cushions that act as a backrest, by contrasting fabric details, it is proposed here in a warm brick-colored shade. Amelia is a model with a dynamic spirit, modular with chaise longue and available on request with wooden slatted base and removable fabric cover.







*mod. Amelia
v. 324
H. mattress 13 cm*







mod. Amelia
v. 326 - 245
H. mattress 13 cm



Maya

Ottimizzare gli spazi domestici, arredare con stile e godere del massimo relax a tutte le ore del giorno e della notte: il divano letto Maya, con la sua seduta tre posti che nasconde un comodo letto singolo, soddisfa ogni aspettativa ed esigenza. Risultato di una sapiente combinazione di volumi, che gli conferiscono un design lineare e facilmente armonizzabile con qualsiasi tipo di arredamento, questo modello è reso unico dalla cura sartoriale dei dettagli: rivestito in tessuto sfoderabile bouclé color senape, con impunture a dare dinamismo alle parti imbottite, è definito da cuciture pizzicate che gli donano spessore e un'attitudine bold. La trasformazione da divano a letto, con apertura orizzontale e materasso orientato trasversalmente rispetto alla seduta, avviene grazie ad un solo movimento: semplicemente ribaltando di 180° la seduta che, nello svelare il piano di riposo, farà in automatico scorrere e sparire nella parte sottostante la spalliera.

The Maya sofa bed flawlessly combines style and functionality, with three seats that conceal a comfortable single bed. Designed to optimize any living space, it provides an elegant furnishing solution while ensuring total relaxation, day or night. The skilful combination of volumes creates a sleek design that integrates effortlessly with any decor style. This model stands out for its meticulous tailored details: upholstered in a removable, mustard-colored, bouclé fabric, it features stitching that enhances the padded elements and pleated seams that add depth and a bold, distinctive character. The sofa transforms into a bed with a single movement, opening horizontally with the mattress turned sideways with respect to the seat. Simply tilt the seat 180° which will automatically slide out and conceal the backrest underneath.







*mod. Maya
v. 320 - D28
H. mattress 13 cm*



Henry

All'apparenza un semplice divano da salotto, austero nella forma e rigoroso nei volumi, il modello Henry è espressione di tradizione artigianale e maniacale cura per i dettagli. Suo punto forte sono senza dubbio i braccioli, caratterizzati dalla generosa imbottitura sagomata e impreziositi da dettagli sartoriali, espressi dagli inserti in nastro gross grain, disponibile in più colori. Concepito come salotto a tre posti con un unico cuscino di seduta e collocato su solidi piedini in metallo, Henry dissimula alla perfezione il suo essere un divano letto, pronto all'uso in qualsiasi momento del giorno o della notte. Il passaggio da salotto a piano di riposo avviene infatti con fluidità di movimento e rapidità di trasformazione, in totale sicurezza e senza rimozione dei cuscini di schienale.

At first sight, a simple living room sofa, with austere shape and rigorous volumes, the Henry model is an expression of artisan tradition and obsessive attention to detail. Its strong point is undoubtedly its armrests, characterized by full shaped padding and embellished with sartorial details, expressed by the inserts in gross grain ribbon, available in several colours. Conceived as a three-seater sofa with a single seat cushion and resting on solid metal feet, Henry perfectly disguises its being a sofa bed, and is ready for use at any time of the day or night. The transition from lounge to sleeping surface occurs with fluid movements and rapid transformation, in total safety and without removing the back cushions.







*mod. Henry
v. 324
H. mattress 13 cm*



Isobel

Il modello Isobel racchiude in sé due anime. La prima è quella immediatamente riconoscibile del moderno salotto tre posti con un'attitudine alla dinamicità, conferitagli dal meccanismo traslante che consente di modificarne la profondità di seduta. La seconda anima, più nascosta, si esprime nella trasformazione in accogliente letto matrimoniale, ottenibile con un semplice movimento di ribaltamento della seduta. Anche in questa seconda versione il dinamismo non manca: le spalliere infatti, tolti i poggiatesta, possono aumentare in altezza assolvendo così al compito di testiera del letto. Dimensione del relax a tutte le ore del giorno e della notte, Isobel è proposto con rivestimento in tessuto in una sobria tonalità neutra, che lo rende facilmente collocabile in qualsiasi ambiente e compatibile con ogni tipo di arredamento.

The Isobel model embodies two spirits. The first is the immediately recognisable one of the modern three-seater sofa characterized by a dynamic look, thanks to the translating mechanism that allows to change the depth of the seat. The second, more hidden, spirit is expressed in the transformation into a welcoming double bed, which can be obtained with a simple tilting movement of the seat. Even this second version confers a very dynamic look: in fact, the backrests, once the lumbar supports have been removed, can increase in height, thus fulfilling the task of a bed headboard. A dimension of relaxation at all hours of the day and night, Isobel is offered with fabric upholstery in a sober neutral shade, which makes it easy to place in any environment and compatible with any type of furniture.







mod. Isobel
v. 324
H. mattress 13 cm



Matilda

Design dal taglio contemporaneo per il divano letto Matilda, punto d'incontro tra estetica, funzionalità e comfort, senza mai rinunciare alla cura artigianale di ogni dettaglio. Pensato come un salotto tre posti con l'ampia seduta composta da un unico cuscino che fa anche da base, si caratterizza per la spalliera bassa, che conferisce a tutta la struttura compattezza e solidità. Componibile anche con chaise longue, Matilda è un modello dall'animo versatile, pronto a svelare in qualsiasi momento il suo potenziale di letto matrimoniale, sul quale è possibile montare un materasso a scelta tra tre diverse densità o in memory foam, in grado di adattarsi perfettamente alla silhouette del corpo.

A contemporary design for the Matilda sofa bed, a meeting point between aesthetics, functionality and comfort, without ever sacrificing the artisanal attention to every detail. Designed as a three-seater sofa with a large seat composed of a single cushion that also serves as a base, it is characterized by the low backrest, which gives the entire structure compactness and solidity. Also modular with a chaise longue, Matilda is a versatile model, ready to reveal its potential as a double bed at any time; the mattress can be chosen among three different densities or can be in memory foam, which adapts perfectly to the contours of the body.







*mod. Matilda
v. 324
H. mattress 13 cm*



Emily

Il modello Emily incarna al meglio lo spirito della collezione Sartoris: trasformare il divano letto in un oggetto di design in cui l'estetica e la funzionalità possano trovare il perfetto connubio. Una mission che si concretizza in questo salotto tre posti dalle volumetrie lineari e la cui ampia e confortevole seduta è chiusa tra braccioli stretti, che limitano al massimo l'ingombro. Il risultato è un divano perfetto per arredare piccoli spazi come monolocali, camere degli ospiti o soggiorni usati come zona notte. La cura sartoriale caratterizza Emily, che abbiamo rivestito in tessuto in fibre naturali, proposto in una calda tonalità che richiama i colori della terra della Valle d'Itria, e rifinito con inserti in un esclusivo nastro in pelle, disponibile a scelta in cinque colori. Oltre che bello, questo divano assicura anche un sonno ristoratore: è infatti disponibile con rete a doghe in legno

The Emily model best embodies the spirit of the Sartoris collection: transforming the sofa bed into a design object in which aesthetics and functionality can find the perfect combination. A mission that materialises in this three-seater sofa with linear volumes and whose large and comfortable seat is closed between narrow armrests, which limit the bulk to the maximum. The result is a sofa perfect for furnishing small spaces such as studio apartments, guest rooms or living rooms which serve as a sleeping area. Emily is characterized by special sartorial care; we have covered it in natural fiber fabric, proposed in a warm shade that recalls the colours of the earth of the Itria Valley, and finished with inserts in an exclusive leather ribbon, available in a range of five colours. In addition to being beautiful, this sofa also ensures a restful sleep: it is in fact available with a wooden slatted base.







mod. Emily
v. 324
H. mattress 16 cm



Meryl

Da classico arredo di servizio, relegato in una stanza secondaria dell'abitazione, con il modello Meryl il divano letto diventa protagonista indiscusso del living, da esibire e vivere a tutte le ore del giorno e della notte. Definito da braccioli a saponetta, che richiamano nella forma i guanciali delle morbide sedute, Meryl si caratterizza per la linea pulita ed essenziale, enfatizzata da piedini in metallo che ne slanciano l'intera struttura e dal rivestimento in pregiato tessuto bouclé, che proponiamo in un'irresistibile tonalità azzurro pastello. Anche in questo modello, il passaggio da divano a letto avviene con un unico movimento rapido e intuitivo, semplicemente tirando la cinghia collocata dietro la spalliera.

With the Meryl model, the sofa bed stops being a classic service piece of furniture, relegated to a secondary room of a house, and becomes the undisputed protagonist of the living room, to be shown off and enjoyed at all hours of the day and night. Defined by soap-shaped armrests, which recall the shape of the pillows of the soft seats, Meryl is characterized by its clean and simple line, emphasised by metal feet that slim the entire structure and by the covering in fine bouclé fabric, in an irresistible pastel blue shade. Also in this model, the transition from sofa to bed occurs with a single quick and simple movement, simply by pulling the strap located behind the backrest.







mod. Meryl
v. 324
H. mattress 13 cm



Dandy

Con Dandy il divano letto, classico arredo di servizio, si trasforma nell'elemento più rappresentativo della zona living, da esporre e proporre come oggetto di design al servizio del riposo, a tutte le ore del giorno e della notte. Sintesi di un'equilibrata compenetrazione di volumi, si caratterizza per l'ampia e soffice spalliera composta da due cuscini volanti, ai quali due elementi imbottiti collocati sul retro conferiscono ulteriore stabilità e sostegno. Definito da braccioli squadrate, ai quali nella parte inferiore va a sovrapporsi la base del divano, l'abbiamo rivestito in tessuto sfoderabile color bianco avorio, rifinito nei bordi con una cucitura pizzicata a delinearne il profilo. Facilmente trasformabile in letto grazie al meccanismo a ribalta integrato, Dandy è disponibile in quattro diverse dimensioni, tra cui la versatile versione "love seat" con ampio materasso singolo largo un metro per sedici comodi centimetri d'altezza.

With the Dandy sofa bed, a classic piece of utilitarian furniture is transformed into a statement piece in the living room, both visually attractive and ideal for relaxation at any time of the day or night. A perfect balance of volumes is the hallmark of this model, with a wide, soft backrest consisting of two loose cushions, supported by two padded elements positioned at the back for greater stability and support. With two squared armrests which overlap the base of the sofa at the bottom, it features a removable, ivory-colored, fabric cover, with pleated edges that highlight the contour. Dandy can be easily transformed into a bed using the built-in lift-up mechanism. It comes in four different sizes including the versatile 'love seat' version with an ultra-comfortable single mattress measuring one metre in width and sixteen centimetres in height.







*mod. Dandy
v. 324
H. mattress 16 cm*



Evelyn

Con Evelyn il divano letto esce dalla stanza degli ospiti per esplorare la zona living. Connotato da volumi compatti e dal design lineare, che gioca con la geometria, il modello è definito da solidi braccioli dal profilo ellittico, esaltato dal dettaglio sartoriale di un inserto in nastro gross grain, disponibile in dieci diverse tonalità. Il motivo della sezione ellittica torna anche nei piedini in pregiato legno, che conferiscono stabilità all'intera struttura. Come tutti i modelli della linea Sartoris, anche Evelyn nasconde un segreto: tirando la cinghia in pelle agganciata dietro allo schienale, quest'ultimo si ribalta per svelare un piano di riposo sul quale è collocato il materasso, disponibile in tre diverse densità o in memory foam, per assecondare ogni idea di comfort.

With Evelyn, the sofa bed leaves the guest room to explore the living area. Characterized by compact volumes and a linear design that plays with geometry, this model is defined by solid armrests with an elliptical profile, enhanced by the sartorial detail of a gross grain ribbon insert, available in ten different shades. The motif of the elliptical section is also reprised in the feet in fine wood, which give stability to the entire structure. Like all models in the Sartoris line, Evelyn also hides a secret: by pulling the leather strap attached behind the backrest, the latter flips over to reveal a resting surface on which the mattress is placed, available in three different densities or in memory foam, to accommodate every comfort requirement.







*mod. Evelyn
v. 324
H. mattress 13 cm*



Flora

Il divano letto Flora risponde alle esigenze della casa contemporanea, i cui spazi diventano sempre più flessibili e multifunzionali. Con i suoi tre posti, integrabili con una chaise longue che nasconde un utile contenitore salva spazio, questo modello si dispone ad essere il punto nevralgico della zona living. Definito da braccioli dalle linee essenziali, qui proposti con rivestimento in pelle ma disponibili anche in tessuto, Flora si inserisce facilmente sia in un arredamento moderno, sia in un contesto più classico. Il rivestimento delle parti imbottite, in tessuto antimacchia idrorepellente e che proponiamo in una tenue tonalità di celeste, lo rende inoltre un modello da vivere in completa tranquillità, liberi dal dramma delle macchie. All'occorrenza, grazie al meccanismo di apertura integrato con sistema a ribalta, Flora può agevolmente passare alla configurazione letto matrimoniale, sul quale abbiamo montato un confortevole materasso di sedici centimetri poggiato su rete metallica elettrosaldata.

The Flora sofa bed meets the demands of the contemporary home where spaces are becoming increasingly flexible and multi-functional. With its three seats and optional chaise longue concealing a handy space-saving storage container, this model will make a bold statement in the living area. Featuring armrests with clean lines, shown here upholstered in leather, but also available in fabric, Flora fits seamlessly into both modern and more classic settings. The cover of the upholstered elements, in stain-resistant and water-repellent fabric, shown here in pale blue, gives you peace of mind, free from the drama of stains. Flora can be easily transformed into a double bed using the built-in, lift-up opening mechanism. The bed features a comfortable sixteen-centimetre-thick mattress resting on an electro-welded wire mesh base.







mod. Flora
v. 330 - 283
H. mattress 16 cm





*mod. Flora
v. 328
H. mattress 16 cm*



Flora

Freddy

Compatto nelle dimensioni ma di grande impatto visivo grazie all'accostamento di due diverse tipologie di rivestimento in tonalità a contrasto – pelle color terracotta per la base e tessuto in una calda nota color crema per le parti imbottite – il modello Freddy si inserisce con carattere anche in ambienti ridotti. Chiuso tra due braccioli slim dal design a saponetta, questo modello risulta particolarmente confortevole grazie alla sua spalliera alta e generosa e alla seduta arrotondata e priva di cuciture. Come sempre, non possono mancare i dettagli sartoriali che fanno la differenza del brand Sartoris e qui rappresentati dalle cuciture pizzicate che definiscono i braccioli, creando un accento visivo che ne valorizza estetica e design. Il letto matrimoniale, perfettamente integrato nella struttura ed estraibile con un semplice e intuitivo movimento a ribalta, ospita un materasso alto ben venti centimetri di altezza, offrendo la migliore esperienza di comfort possibile.

The Freddy model is compact in size but with an eye-catching design, combining two different types of covers in contrasting colours – terracotta leather for the base and a warm cream fabric for the padded parts – to make a bold statement in small spaces. Encompassed by two slim 'soap-bar' shaped armrests, this model is ultra-comfortable with its broad, high backrest and seamless, rounded seat. As always, the tailoring details are the statement feature of the Sartoris brand, showcased here by the pleated seams defining the armrests, emphasising the visual appeal and design. The double bed, that slots seamlessly into the sofa and can be pulled out with a simple, intuitive movement, has a twenty-centimetre-thick mattress, to ensure total comfort.







*mod. Freddy
v. 324
H. mattress 20 cm*



George

Si presenta come un semplice divano da salotto, austero nella forma e imponente nei volumi delle parti imbottite: il divano letto George vuole però esprimere anche anni di tradizione, cura e sapienza artigianali messe al servizio della praticità e del buon riposo, a tutte le ore del giorno e della notte. Rivestito in tessuto dalle tonalità neutre, impreziosito dal dettaglio sartoriale delle cuciture decorative in tinta o a contrasto, questo modello – grazie alle imbottiture in poliuretano espanso dell'ampia seduta e dello schienale – risulta particolarmente confortevole e accogliente. Trasformabile in letto matrimoniale con un semplice movimento di ribaltamento della seduta, George assicura un sonno ristoratore grazie ad un materasso di sedici centimetri di altezza.

It presents itself as a simple living room sofa, with austere shape and imposing volumes of its padded parts: the George sofa bed also wants to express years of tradition, care and artisanal knowledge put at the service of practicality and good rest, at all hours of the day and night. Covered in neutral-toned fabric, embellished with the sartorial detail of matching or contrasting decorative stitching, this model – thanks to the polyurethane foam padding of the large seat and backrest – is particularly comfortable and welcoming. Transformable into a double bed with a simple tilting movement of the seat, George ensures a restful sleep thanks to a sixteen-centimetre-high mattress.







*mod. George
v. 324
H. mattress 16 cm*



Laurence

Moderno divano da salotto e dimensione perfetta per momenti di svago e convivialità, Laurence in pochi attimi e con un solo gesto si trasforma in letto, disponendosi ad accogliere anche il riposo notturno. Caratterizzato dall'ampia seduta, chiusa tra braccioli dal particolare profilo a saponetta, si distingue per lo schienale morbido e confortevole nel quale abbiamo integrato, per conferirgli un plus di comfort, due soffici poggiatesta. Collocato su piedini a spillo, che ne slanciano la silhouette e liberano il pavimento sottostante, l'abbiamo rivestito con un pratico tessuto sfoderabile impreziosito sui braccioli da cuciture decorative in tinta o a contrasto. Lo proponiamo nella tonalità neutra del verde salvia, conciliante il sonno e il relax.

A modern living room sofa and the perfect size for moments of leisure and conviviality, Laurence transforms into a bed in a few moments and with a single movement, also ready to welcome a night's rest. Characterized by the large seat, closed between armrests with a particular soap-shaped profile, it stands out for its soft and comfortable backrest in which we have integrated, to give it extra comfort, two soft lumbar supports. Placed on pin feet, which make its contours look slimmer and which clears the floor underneath, we have covered it with a practical removable fabric embellished on the armrests with decorative stitching in the same colour or in contrast. We offer it in the neutral shade of sage green, which helps with sleep and relaxation.







*mod. Laurence
v. 324
H. mattress 13 cm*



Moon

Design essenziale e preziosi dettagli espressione di artigianalità: il divano tre posti Moon, con i suoi volumi compatti e lineari, sintetizza estetica e praticità. Ampliabile con chaise-longue, in Moon si concretizza tutta la maestria delle sapienti mani dei nostri artigiani. I tiraggi orizzontali che donano dinamismo ai braccioli, il pregevole nastro decorativo a definire in lunghezza la sponda frontale, le impunture sulle parti imbottite: ogni particolare parla di cura e attenzione per il bello. Il rivestimento in tessuto smacchiabile con acqua e la doppia anima di divano e letto matrimoniale lo rendono inoltre un modello particolarmente versatile, adatto ad assecondare le esigenze della vita di ogni giorno. Intuitivo è il passaggio alla configurazione letto. Il meccanismo "easy bed" consente infatti di ottenere un piano di riposo in due movimenti, semplicemente giustapponendo le parti imbottite di seduta e spalliera.

Essential design and precious details are an expression of craftsmanship: the Moon three-seater sofa, with its compact and linear volumes, synthesizes aesthetics and practicality. Expandable with a chaise longue, Moon is the perfect application of the all the mastery of the expert hands of our craftsmen. The horizontal pulls that give dynamism to the armrests, the fine decorative ribbon that defines the length of the front side, the stitching on the padded parts: every detail speaks of care and attention to beauty. The fabric covering is stain-removable, just with water. The double soul of sofa and double bed also make this model versatile, suitable for everyday life needs. The transition to the bed configuration is intuitive. The "easy bed" mechanism allows you to obtain a resting surface in two movements, simply placing side by side the seat and back elements.







mod. Moon
v. 244 - 329





mod. Moon
v. 324



Naomy

Attitudine romantica e sognante quella di Naomy: un divano letto con seconda rete estraibile che appaga nello stesso tempo estetica e funzionalità. Caratterizzato da braccioli e spalliere disponibili in due diverse altezze abbinabili tra loro, questo modello si completa con un set di morbidi cuscini in piuma d'oca, cui abbiamo aggiunto due ulteriori cuscini cilindrici. Espressione di cura artigianale è inoltre la pregevole trapuntatura che caratterizza il tessuto di rivestimento della seduta e della base. Il modello Naomy, oltre che soddisfare l'occhio e offrire un comfort perfetto in qualsiasi momento della giornata, esprime però al meglio il suo potenziale nel passaggio alla configurazione doppio letto singolo. Un primo piano di riposo corrisponde infatti alla seduta, mentre un ulteriore letto singolo si otterrà facendo scorrere fuori dalla base una seconda rete che, semplicemente attivando una leva, potrà essere portata all'altezza dell'altra.

The Naomy model has a romantic, dreamlike air to it: a sofa bed with a second pull-out bed base that is both attractive and functional. With arm and backrests available in two different combinations of heights, this model is completed with a set of soft, goose-down cushions, plus two extra cylindrical cushions. The elegant quilting of the seat and base fabric cover adds a touch of artisanal detail. The Naomy model is not only visually attractive but also ultra-comfortable at any time of day, with the added bonus of transforming into two single beds. The first bed is formed by the seat area while a another single bed is obtained by pulling out a second base that is raised to the height of the other bed by simply pressing a lever.







mod. Naomi
v. 327 set B
H. mattress 15 cm - D30



Violet

Frutto di una costante ricerca per offrire soluzioni sempre nuove, il modello Violet rappresenta una sorprendente versione di divano letto, coerente con le esigenze sempre più complesse della vita contemporanea e di spazi abitativi sempre più ridotti. Nella configurazione come divano, si presenta come un modello dalle linee minimali ed equilibrate: il bracciolo è squadrato e caratterizzato lateralmente da un tiraggio decorativo che gli conferisce dinamismo; le spalliere sono invece composte da cuscini volanti, facilmente rimovibili nel passaggio da divano a letto. Grazie al rivestimento in tessuto ignifugo smacchiabile con acqua, Violet si presta inoltre tranquillamente ad un uso quotidiano. È però nella versione letto che questo modello si esprime al meglio, rappresentando una proposta unica. Attivando un sistema brevettato di meccaniche, Violet rivela al suo interno ben due letti singoli, il primo inferiore e il secondo sollevato, trasformandosi di fatto in una struttura a castello completa di scaletta e banda di protezione. Il tutto in totale sicurezza, grazie ad un collaudato sistema di blocchi con chiavi rimovibili. All'esigenza Violet può però essere usato anche come letto singolo, semplicemente rimuovendo rivestimento e spalliere.

The Violet model, stemming from ongoing research for innovative solutions, is an unexpected version of the sofa bed, meeting even the most challenging demands of contemporary lifestyle and ever-shrinking living spaces. In the sofa configuration, it features minimal, balanced lines: the armrest is square with a decorative pull on the side that gives it a sense of movement while the backrests consist of loose cushions, that can be easily removed when transforming the sofa into a bed. Violet is also suitable for everyday use with its fire-retardant, water-repellent fabric cover. It is in the bed version, however, that this model comes into its own. By activating a patented mechanical system, Violet reveals two single beds inside it, the first lower and the second raised up, thus transforming into bunk beds, complete with ladder and protective sides. All in total safety thanks to a tried and tested locking system with removable keys. Violet can also be used as a single bed, if required, by simply removing the cover and backrest.







*mod. Violet
v. 327
H. mattress 16 cm - D30*



Loll

Facilmente adattabile a qualsiasi stile di arredamento grazie ad un design pulito e senza tempo, il divano tre posti Loll è anche agilmente collocabile in spazi ridotti in virtù delle sue dimensioni contenute: i sottili braccioli dal classico profilo a saponetta ne ottimizzano infatti al massimo l'ingombro, definendo l'alloggio per due morbidi cuscini amovibili che fanno da spalliera. Come tutti i salotti Sartoris, si tratta di un prodotto che esprime cura artigianale e maestria sartoriale: l'abbiamo infatti rivestito in tessuto bianco ghiaccio interamente sfoderabile e rifinito tutte le parti imbottite con nastro gross grain blu. Attivando il meccanismo brevettato Rolling System, con un semplice movimento a ribalta Loll passa dalla versione divano a quella letto. Per assecondare ogni esigenza, lo proponiamo in due diverse opzioni: due letti singoli separati o letto matrimoniale. Disponibile inoltre in versione poltrona convertibile in letto singolo.

Easily adaptable to any furnishing style thanks to its clean and timeless design, the three-seater sofa Loll is also easily placed in reduced spaces because of its compact dimensions: the slim armrests with their classic boxed profile optimise the overall dimensions, defining the space for two soft removable cushions that act as backrests. Like all Sartoris lounges, this is a product that expresses craftsmanship and sartorial mastery: we have upholstered it in ice-white fabric with a fully removable and finished all upholstered parts with blue gross grain piping. By activating the patented Rolling System mechanism, Loll switches from sofa to bed version with a simple flap movement. To meet every need, we offer it in two different options: two separate single beds or a double bed. Also available in as armchair that converts into a single bed.







mod. Loll
v. 324
H. mattress 13 cm





*mod. Loll
v. 327
H. mattress 13 cm*



Loll

Jason

Concepito come elemento catalizzatore della zona living, Jason è un ampio divano angolare con penisola terminale e solido bracciolo dal volume squadrato. Molto più che un semplice salotto intorno al quale vivere momenti di convivialità e relax, questo modello gioca la sua carta vincente trasformandosi all'occorrenza in un accogliente letto matrimoniale. Dotato di ben tre poggiatesta reclinabili e di un'ampia seduta, si colloca su piedi in metallo che lo staccano da terra conferendogli slancio e leggerezza nonostante le ampie dimensioni. Realizzato con cura sartoriale, Jason è proposto in un pregevole tessuto color grigio cenere, dall'avvolgente effetto vellutato e rifinito con bordino gross grain, personalizzabile scegliendo una tonalità tra le dieci disponibili.

Conceived as a catalyst for the living area, Jason is a large corner sofa with a peninsula and a solid armrest with a square volume. Much more than a simple sofa for your moments of conviviality and relaxation, this model plays its trump card by transforming itself into a welcoming double bed. Equipped with three reclining headrests and a large seat, it is placed on metal feet that lift it from the ground, giving it momentum and lightness despite its large dimensions. Made with sartorial care, Jason is proposed in a fine ash grey fabric, with an enveloping velvety effect and finished with a gross grain border, customizable by choosing a shade from the ten available.







mod. Jason
v. 326 - 341
H. mattress 13 cm



Otto

Le dimensioni contenute, unite alla sobria eleganza del design, rendono il divano letto Otto la soluzione perfetta per arredare con versatilità gli spazi di casa, assecondando tutte le esigenze della vita contemporanea. Con un solo e semplice gesto, il divano si trasforma infatti in un accogliente letto matrimoniale, sempre pronto ad offrire comfort e riposo. Proposto con rivestimento in tessuto idrorepellente, Otto può essere personalizzato scegliendo per il bordino gross grain, che definisce il profilo dei braccioli, una tonalità a contrasto tra le dieci disponibili. La basetta a slitta in metallo verniciato ne solleva infine da terra l'intera struttura, facilitando così le quotidiane operazioni di pulizia. Disponibili in abbinamento, cuscini e poggiatesta.

Its small dimensions, combined with the sober elegance of the design, make the Otto sofa bed the perfect solution for furnishing your home with versatility, satisfying all the needs of contemporary life. With a single and simple movement, the sofa transforms into a welcoming double bed, always ready to offer comfort and rest. Available with waterproof fabric upholstery, Otto can be customized by choosing a contrasting shade from the ten available for the gross grain piping, which defines the profile of the armrests. The painted metal sled base finally raises the entire structure from the ground, thus facilitating daily cleaning operations. Matching cushions and lumbar supports are available.







mod. Otto
v. 324
H. mattress 13 cm



Byblos

Giochi di volumi conferiscono solidità e caratterizzano il divano letto Byblos: modello che ambisce a combinare il massimo della funzionalità e del comfort con una resa estetica di alta gamma. Grazie alla sua doppia anima, che si esprime attraverso meccaniche integrate, Byblos asseconda il bisogno di riposo ad ogni ora del giorno e della notte: è infatti dotato di poggiatesta reclinabili, così come con un unico movimento a ribalta avviene il passaggio da salotto a letto matrimoniale, sul quale abbiamo montato un materasso alto tredici centimetri. Prezioso e ricercato nel suo rivestimento in pelle color crema con impunture sulla parte esterna dei braccioli, questo modello esprime ricercatezza in ogni dettaglio, compresi i piedini metallici dal particolare profilo a lama rastremata.

Plays of volumes give solidity and characterise the Byblos sofa bed: a model that aims to combine maximum functionality and comfort with a high-end aesthetic result. Thanks to its dual spirit, which is expressed through integrated mechanisms, Byblos satisfies the need for rest at any time of the day or night: it is in fact equipped with reclining headrests, and with a single tilting movement it becomes a double bed, on which we have installed a thirteen-centimetre high mattress. Precious and refined in its cream-coloured leather upholstery with stitching on the outside of the armrests, this model expresses refinement in every detail, including the metal feet with a particular tapered blade profile.







*mod. Byblos
v. 324
H. mattress 13 cm*



Dora

Ideale per creare un'oasi di relax sia nella zona living che in quella notte, la poltroncina a pozzetto Dora è destinata a diventare parte imprescindibile dell'arredo e della vita di ogni giorno. Avvolgente e accogliente, l'abbiamo rivestita in un tessuto dalle sobrie tonalità del tortora, esaltato da impunture e finiture espressione di cura artigianale. Dora è collocata su un'ampia base swivel in metallo sabbato, che le conferisce stabilità ed insieme dinamismo.

Ideal for creating a cosy corner in which to relax in both the living room and bedroom, the Dora tub armchair will become an indispensable part of your furnishing and everyday life. It is comfy and cosy, upholstered in fabric featuring understated tones of dove grey, highlighted by the fine artisanal stitching and finishes. Dora rests on a wide swivel base in satin-finish metal that gives it both stability and movement.



Alice

Caratterizzata dalla compattezza dei volumi e dal design essenziale, la poltrona Alice è un vero jolly da giocare in ogni occasione: serve un letto extra per gli ospiti: sarà sufficiente rimuovere il rivestimento e, in pochi passaggi, attivare il meccanismo che svela una rete con materasso singolo. Rivestita in tessuto sfoderabile color ruggine, dalla texture vellutata e dal particolare effetto 3D, Alice punella sua funzionalità e esprime pregevolezza artigianale e cura per il dettaglio.

The Alice armchair has a compact, minimal design that is always on hand when you need an extra bed for guests. Just remove the cover and activate the mechanism to reveal a bed base with a single mattress in a few simple steps, complete with a softly padded headrest. Featuring a rust-colored removable fabric cover with a velvety texture and an unusual 3D effect, despite its functionality, Alice also demonstrates fine craftsmanship and attention to detail, as showcased by the handy storage pocket on the headrest of the bed.



mod. Alice
v. 120
H. mattress 11 cm - D28

Olivia

Essenziale nel design e facilmente inseribile in ogni ambiente, la poltrona Olivia definisce una dimensione pensata per il relax e per il riposo. In una vibrante tonalità rosso ciliegia, l'abbiamo rivestita in tessuto dalla lavorazione sartoriale a trapunta, sia sulla spalliera che sulla seduta. All'occasione Olivia si reinventa letto ad una piazza: reclinando lo schienale, mantenendo fissa la seduta ed estraendone dal vano collocato al di sotto la parte terminale, in pochi gesti si andrà a configurare un piano di riposo, pronto ad accogliere il sonno di un ospite inatteso

Essential design and easy to fit into any environment, the Olivia armchair defines a dimension for relaxation and rest. In a vibrant cherry red shade, it is upholstered in a tailored quilted fabric, both on the back and the seat cushions. Occasionally, Olivia reinvents itself as a single bed: by reclining the backrest, keeping the seat fixed and extracting the end piece from the compartment underneath, in just a few gestures you will be able to set up a resting surface, ready to welcome the sleep of an unexpected guest.



Gigi

Molto più che un semplice pouf da spostare nello spazio del living ovunque serva una seduta aggiuntiva o un poggiatesta, Gigi rivela all'occorrenza una terza e inaspettata opzione di utilizzo. Rimuovendone infatti il rivestimento in tessuto, si andrà a svelare una rete con materasso ad una piazza, facilmente componibile in pochi passaggi attraverso l'attivazione del nostro meccanismo brevettato. Ecco svelato un comodo letto singolo, ideale soluzione salvaspazio e "salva ospite" in abitazioni giovani e dinamiche.

More than a simple pouf to move around the living space wherever an additional seat or footstool is needed, Gigi reveals a third and unexpected option of use when needed. While removing the fabric cover it shows a single bed base with mattress, easily assembled in just a few steps by activating our patented mechanism. Here is revealed a comfortable single bed, an ideal space-efficiency and 'guest-saving' solution in young and dynamic homes.



mod. Gigi
v. 516
H. mattress 11 cm - D28

Ugo

Giocoso e dallo spirito irriverente è il trio di pouf Ugo: morbidi funghi spuntati nella zona living, pensati per fare la differenza in un arredamento contemporaneo e informale. Disponibili in tre altezze e in diversa ampiezza di seduta, possono essere personalizzati nel rivestimento scegliendo diversi abbinamenti tra pelle o tessuto. effetto3D, Alicepurnella sua funzionalità esprime pregevolezza artigianale e cura per il dettaglio.

The trio of Ugo poufs offers a fun, irreverent addition to your home with soft mushrooms sprouting in the living room, designed to shake up contemporary and informal layouts. Available in three different heights and seat widths, the covers can be customised by choosing different combinations of either leather or fabric.



Pio

Utilizzabile come poggiatesta o come sedute extra da abbinare al divano, il trio di pouf Pio aggiunge un tocco di creatività e un plus di comfort all'arredamento del salotto. Pensati in tre versioni diverse – con seduta tonda, quadrata e rettangolare – i pouf sono personalizzabili nei rivestimenti e nelle cuciture decorative a contrasto cromatico. Pio è inoltre disponibile nella versione panca.

The trio of Pio poufs can be used as a footrest or as an extra seat in combination with the sofa, thus adding a touch of creativity and comfort to the living room layout. Designed in three different versions featuring a round, square or rectangular seat with the option of customising the cover and decorative stitching in a contrasting colour. Pio is also available in a bench version.



Tic Tac

Duo di tavolini da salotto espressione di spiriti antitetici e complementari: lineare e solido l'uno, tondeggiante e morbido l'altro. Il primo tavolino, dal design essenziale, è interamente in metallo caratterizzato da diverse finiture e colorazioni: cromate lucide le tre gambe, opaco color sabbia il ripiano, del diametro di sessantadue centimetri. Il secondo tavolino vede invece integrato lo stesso ripiano in metallo all'interno di una struttura imbottita con rivestimento in ecopelle, caratterizzata dal dettaglio sartoriale di cuciture a fasce verticali.

A pair of coffee tables expressing contrasting and complementary spirits: linear and solid the one, rounded and soft the other. The first coffee table with its understated design, is made entirely of metal featuring different finishes and colours: shiny chrome for the three legs and a matt sandy colour for the top with a diameter of sixty-two centimetres. The second coffee table has the same metal top integrated in a padded structure upholstered with eco-leather featuring tailored seams and vertical bands.



Neo

Con la sua estetica che gioca con le geometrie, il duo di coffee table Neo è il perfetto complemento per un arredamento dal mood contemporaneo e minimale. Risultato della sapiente composizione di un ripiano in metallo poggiato su tre gambe, di cui due composte da una slitta e la terza caratterizzata da una sfera decorativa in metallo cromato a fare da perno, il tavolino Neo è disponibile in due altezze e diametri differenti. Ampia la possibilità di personalizzare le finiture di ripiano e slitta, proposti in quattro varianti: metallo cromato lucido o satinato, nero opaco, sabbia.

With its visual play on shapes, the pair of Neo coffee tables is the perfect accessory to furnishing with a contemporary and minimal mood. The Neo coffee table combines an elegant design with functional artistry, featuring a metal top supported by three legs: two forming a sleek sled base and the third incorporating a decorative chrome-plated metal sphere that serves as a pivot. It comes in two different heights and diameters, plus lots of customisation options available for the finishes of the top and sled base, in four variations: glossy or satin-finished chrome metal, matt black, and sand.



Teo

Perfetto complemento per il divano letto, il duo di pouf Teo si presta con versatilità ad essere impiegato come comoda seduta aggiuntiva o poggiatesta, ma anche come contenitore salvaspazio per riporre lenzuola e coperte pronte all'uso. Proposto con base quadrata o rettangolare e rivestito in tessuto personalizzabile, esaltato da finiture dal gusto sartoriale, Teo può essere agevolmente spostato e aperto grazie alla sua cinghia in cuoio integrata.

A perfect complement to the sofa bed, the duo of Teo pouf lends itself with versatility to be used as a comfortable additional seat or footrest, but also as a storage-space container for sheets and blankets. Offered with a square or rectangular base and upholstered in customized fabrics, enhanced by tailored finishes, Teo can be easily moved and opened thanks to its integrated leather strap.



Patented model

Rolling System
mechanism

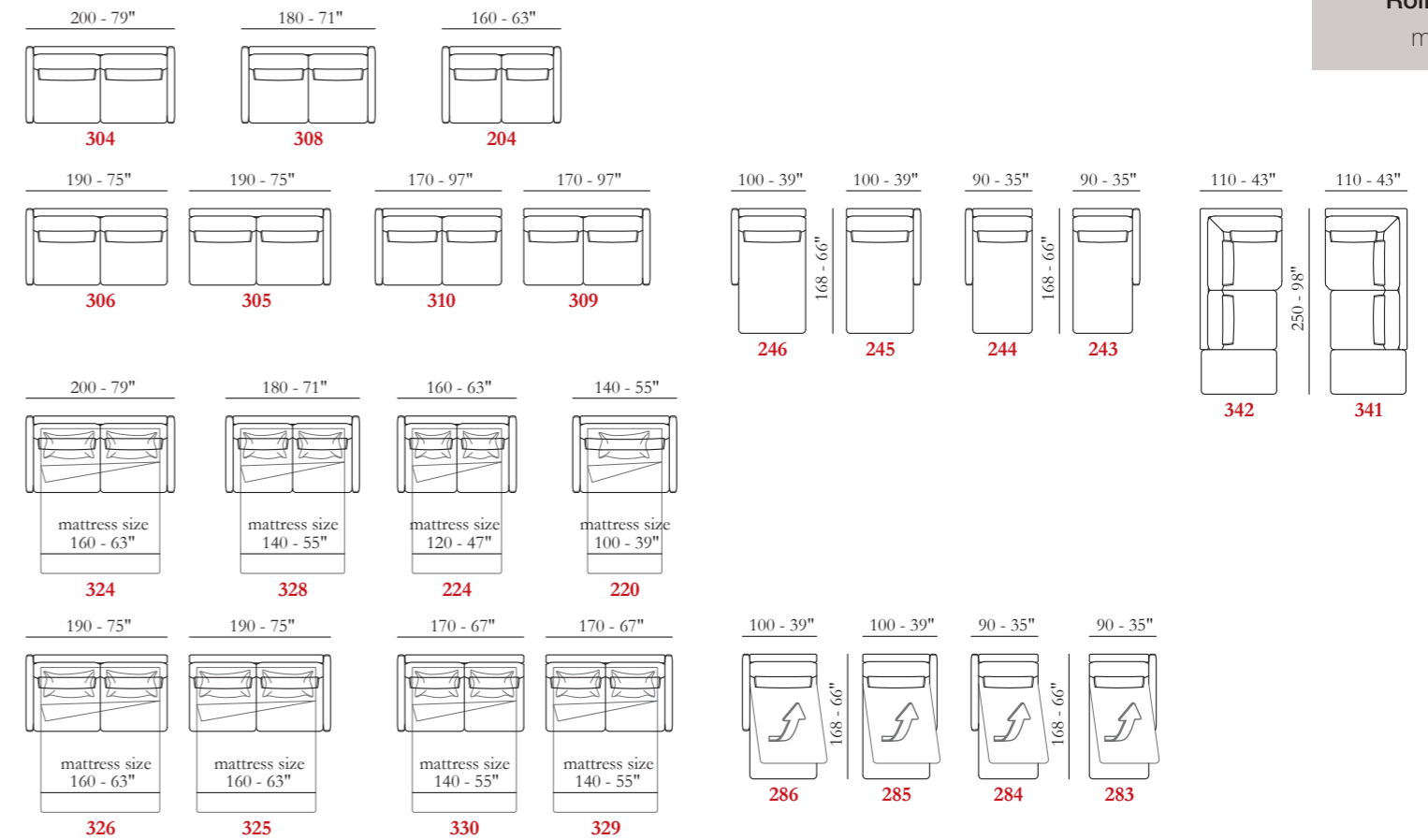
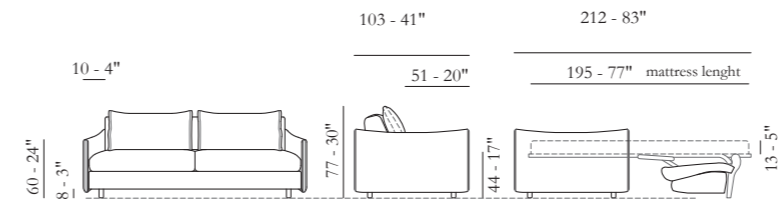

Esempi di componibilità - Sectionals examples - Exemples de compositions - Ejemplos de modularidad

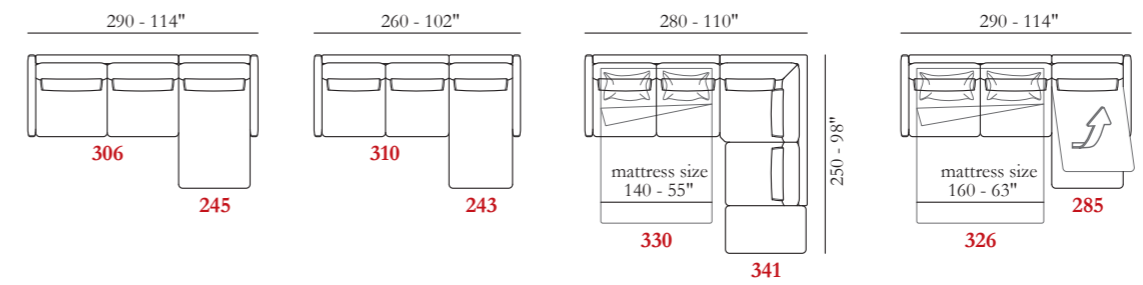

Modello disponibile con rivestimento non sfoderabile
Model also available with fixed covers
Modèle disponible aussi avec coussins non déhoussable
Modelo también disponible con tapas fijas.

Modello disponibile con rete a doghe in legno.
Model also available with wooden slats.
Modèle disponible aussi avec sommier à lattes
Modelo también disponible somier de lamas de madera.



H. materasso 13 cm
H. mattress 13 cm
H. matelas 13 cm
H. colchón 13 cm



Schede Tecniche / Technical sheets

- Divani letto / Sofa bed**
- Poltrone / Armchairs**
- Poltrone letto / bed armchairs**
- Tavolini / Coffee tables**
- Pouff / Ottoman**
- Pouff contenitore / Storage ottoman**
- Plaid / Plaid**

Rivestimento
Tessuto (Sfoderabile)
Imbottitura
BRACCIOLI / Poliuretano espanso
SEDUTA / Poliuretano espanso
SPALLIERA / Fibra di poliestere
Comfort Standard
Piedi Metallo
Struttura Telaio in legno

Coverings
Fabric (Removable)
Rembourrage
ARMS / Foam
SEAT CUSHION / Foam
BACK CUSHION / Fiber
Comfort Standard
Legs Metal
Structure Wooden frame

Revêtement
Tissu (Déhoussable)
Rembourrage
ACCOUDOIRS / Mousse
ASSISE / Mousse
DOSSIER / Flocons de polyester
Comfort Standard
Pieds Metal
Structure Structure en bois

Revestimiento
Tela (Extraible)
Imbottitura
APOYABRAZOS / Poliuretano expandido
SENTADA / Poliuretano expandido
RESPALDO / Fibras de poliéster
Comfort Estándar
Pies Metal
Struttura Estructura en madera

Aurora

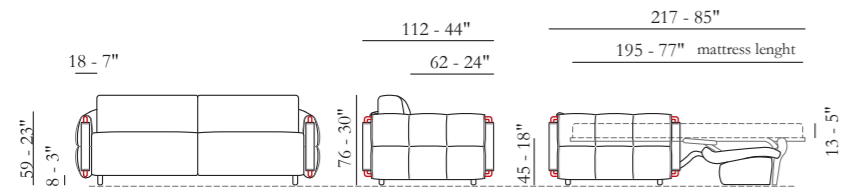

Patented model

Rolling System mechanism

Finiture Inserto Bracciolo /
Finishing Insert Arms / Finition Insert accoudoirs / Acabados Insert apoyabrazos

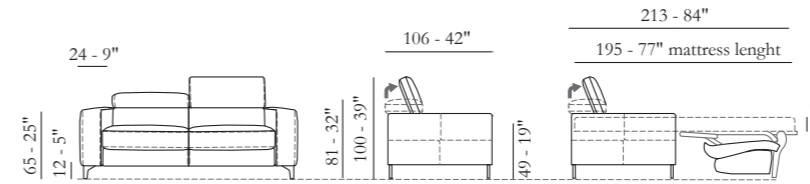
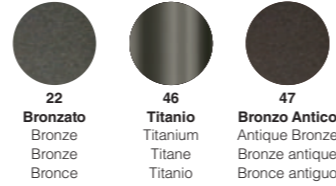

Patented model

Rolling System mechanism

Finitura piedi / Legs finishes
Finition de pieds / Acabados de pies

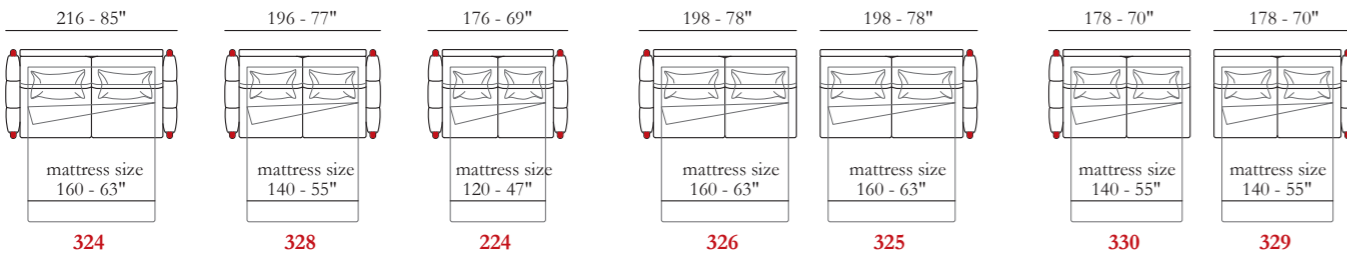
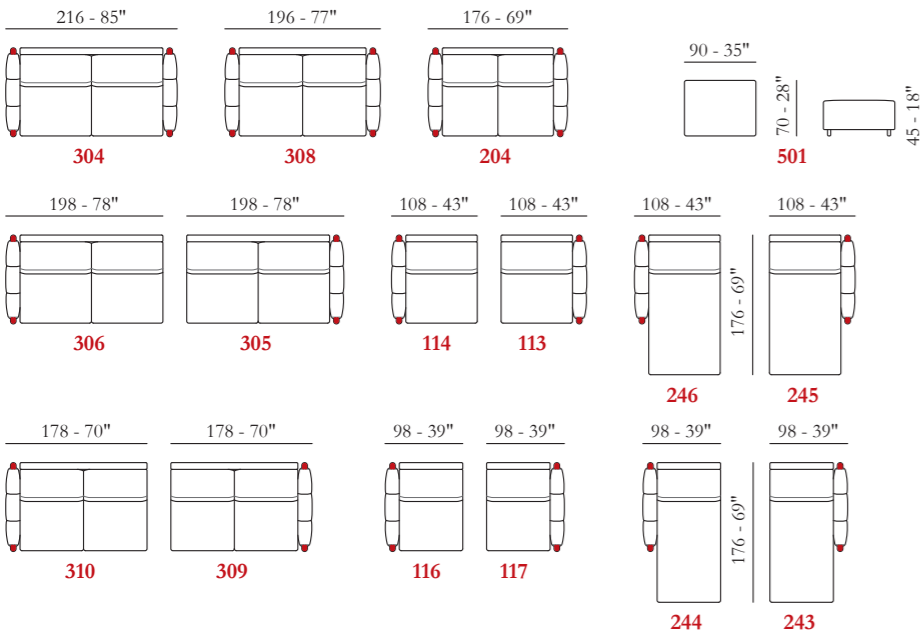

Esempi di componibilità - Sectionals examples - Exemples de compositions - Ejemplos de modularidad

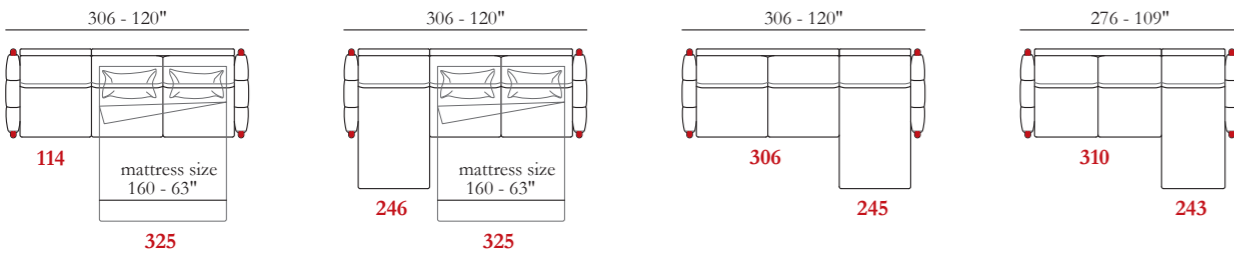

H. materasso 13 cm
H. mattress 13 cm
H. matelas 13 cm
H. colchón 13 cm



H. materasso 13 cm
H. mattress 13 cm
H. matelas 13 cm
H. colchón 13 cm

Rivestimento
Pelle / Tessuto BRACCIOLO (non Sfoderabile)
Tessuto (Sfoderabile)
Imbottitura
BRACCIOLI / Fibra in cotone
SEDUTA / Poliuretano espanso
SPALLIERA / Poliuretano espanso
Opzioni Cucitura a contrasto
Comfort Standard
Piedi Metallo
Finiture Inserto Bracciolo
22 / 46 / 47
Struttura Telaio in legno

Coverings
Leather / Fabric ARMS (not Removable)
Fabric (Removable)
Filling
ARMS / Cotton fiber
SEAT CUSHION / Foam
BACK CUSHION / Foam
Options Contrast stitching
Comfort Standard
Legs Metallo
Finishing Insert Arms
22 / 46 / 47
Structure Wooden frame

Revêtement
Cuir / Tissu ACCOUDOIRS (pas Déhoussable)
Tissu (Déhoussable)
Rembourrage
ACCOUDOIRS / Fibre de coton
ASSISE / Mousse
DOSSIER / Mousse
Options Coutures contrastées
Confort Standard
Pieds Metallo
Finition Insert accoudoirs
22 / 46 / 47
Structure Structure en bois

Revestimiento
Piel / Tela APOYABRAZOS (no Extraible)
Tela (Extraible)
Imbottitura
APOYABRAZOS / Fibra de algodón
SENTADA / Poliuretano expandido
RESPALDO / Poliuretano expandido
Opciones Costura en contraste
Confort Estándar
Pies Metallo
Acabados Insert apoyabrazos
22 / 46 / 47
Struttura Estructura en madera

Rivestimento
Pelle / Tessuto
Imbottitura
BRACCIOLI / Poliuretano espanso
SEDUTA / Poliuretano espanso
SPALLIERA / Poliuretano espanso
Opzioni Cucitura a contrasto
Comfort Standard
Piedi Metallo
Finiture 10 / 11
Struttura Telaio in legno

Coverings
Leather / Fabric
Filling
ARMS / Foam
SEAT CUSHION / Foam
BACK CUSHION / Foam
Options Contrast stitching
Comfort Standard
Legs Metal
Finishing 10 / 11
Structure Wooden frame

Revêtement
Cuir / Tissu
Rembourrage
ACCOUDOIRS / Mousse
ASSISE / Mousse
DOSSIER / Mousse
Options Coutures contrastées
Confort Standard
Pieds Metal
Finition 10 / 11
Structure Structure en bois

Revestimiento
Piel / Tela
Imbottitura
APOYABRAZOS / Poliuretano expandido
SENTADA / Poliuretano expandido
RESPALDO / Poliuretano expandido
Opciones Costura en contraste
Confort Estándar
Pies Metal
Acabados 10 / 11
Struttura Estructura en madera

Dandy

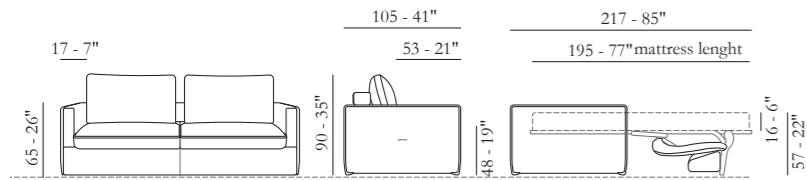

Patented model

Rolling System mechanism

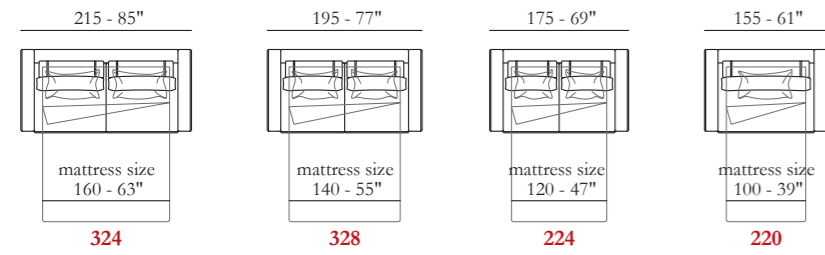

Elodie

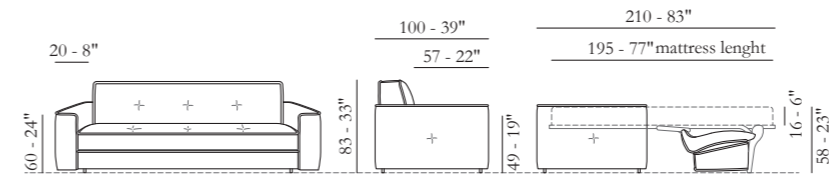

Patented model

Rolling System mechanism

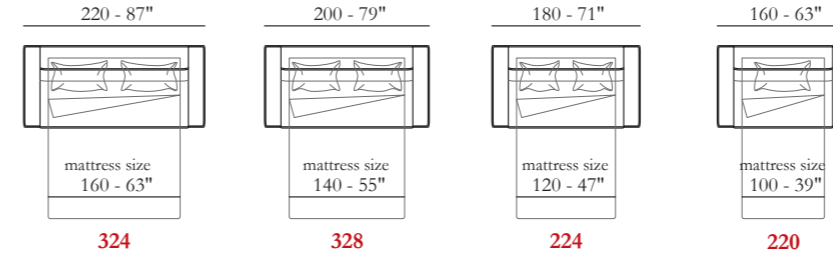

H. materasso 16 cm
H. mattress 16 cm
H. matelas 16 cm
H. colchón 16 cm



H. materasso 16 cm
H. mattress 16 cm
H. matelas 16 cm
H. colchón 16 cm

Rivestimento

Tessuto (Sfoderabile)

Imbottitura

BRACCIOLI / Poliuretano espanso

SEDUTA / Poliuretano espanso

SPALLIERA / Fibra di poliestere

Opzioni Cucitura a contrasto

Comfort Standard

Piedi Metallo

Struttura Telaio in legno

Coverings

Fabric (Removable)

Filling

ARMS / Foam

SEAT CUSHION / Foam

BACK CUSHION / Fiber

Options Contrast stitching

Comfort Standard

Legs Metal

Structure Wooden frame

Revêtement

Tissu (Déhoussable)

Rembourrage

ACCOUDOIRS / Mousse

ASSISE / Mousse

DOSSIER / Flocons de polyester

Options Coutures contrastées

Confort Standard

Pieds Metal

Structure Structure en bois

Revestimiento

Tela (Extraible)

Imbottitura

APOYABRAZOS / Poliuretano expandido

SENTADA / Poliuretano expandido

RESPALDO / Fibras de poliéster

Opciones Costura en contraste

Confort Estándar

Pies Metal

Struttura Estructura en madera

Rivestimento

Tessuto (Sfoderabile)

Imbottitura

BRACCIOLI / Poliuretano espanso

SEDUTA / Poliuretano espanso

SPALLIERA / Poliuretano espanso

Comfort Standard

Piedi Metallo

Struttura Telaio in legno

Coverings

Fabric (Removable)

Imbottitura

ARMS / Foam

SEAT CUSHION / Foam

BACK CUSHION / Foam

Comfort Standard

Legs Metal

Structure Wooden frame

Revêtement

Tissu (Déhoussable)

Rembourrage

ACCOUDOIRS / Mousse

ASSISE / Mousse

DOSSIER / Mousse

Confort Standard

Pieds Metal

Structure Structure en bois

Revestimiento

Tela (Extraible)

Imbottitura

APOYABRAZOS / Poliuretano expandido

SENTADA / Poliuretano expandido

RESPALDO / Poliuretano expandido

Confort Estándar

Pies Metal

Struttura Estructura en madera

Emily

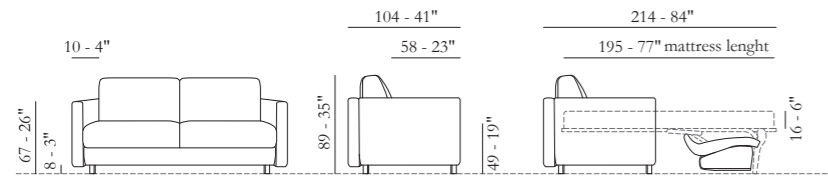

Patented model

Rolling System mechanism

Finitura piedi / Legs finishes
Finition de pieds / Acabados de pies

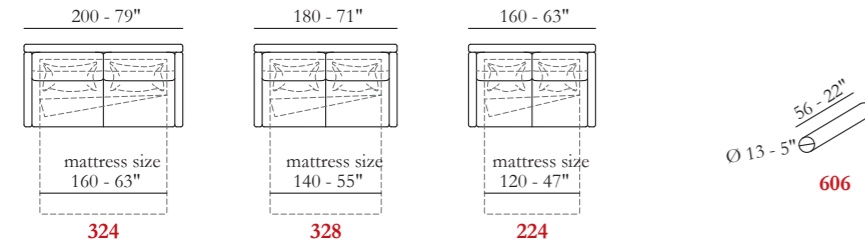
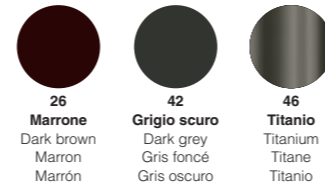

324 328 224



Nastro in pelle
Leather ribbon
Ruban en cuir
Cinta de cuero



Rivestimento
Tessuto (Sfoderabile)
Imbottitura
BRACCIOLI / Poliuretano espanso
SEDUTA / Poliuretano espanso
SPALLIERA / Poliuretano espanso
Opzioni Cucitura a contrasto
Comfort Standard
Piedi Metallo
Finiture 26 / 42 / 46
Struttura Telaio in legno

Coverings
Fabric (Removable)
Filling
ARMS / Foam
SEAT CUSHION / Foam
BACK CUSHION / Foam
Options Contrast stitching
Comfort Standard
Legs Metal
Finishing 26 / 42 / 46
Structure Wooden frame

Revêtement
Tissu (Déhoussable)
Rembourrage
ACCOUDOIRS / Mousse
ASSISE / Mousse
DOSSIER / Mousse
Options Coutures contrastées
Confort Standard
Pieds Metal
Finition 26 / 42 / 46
Structure Structure en bois

Revestimiento
Tela (Extraible)
Imbottitura
APOYABRAZOS / Poliuretano expandido
SENTADA / Poliuretano expandido
RESPALDO / Poliuretano expandido
Opciones Costura en contraste
Confort Estándar
Pies Metal
Acabados 26 / 42 / 46
Struttura Estructura en madera

Modello disponibile con rete a doghe in legno.
Model also available with wooden slats.
Modèle disponible aussi avec sommier à lattes
Modelo también disponible somier de lamas de madera.

H. materasso 16 cm
H. mattress 16 cm
H. matelas 16 cm
H. colchón 16 cm

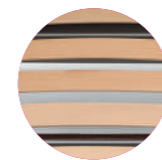

Eudora

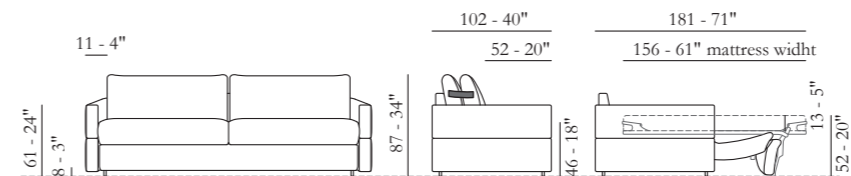

Patented model

Reverse System mechanism

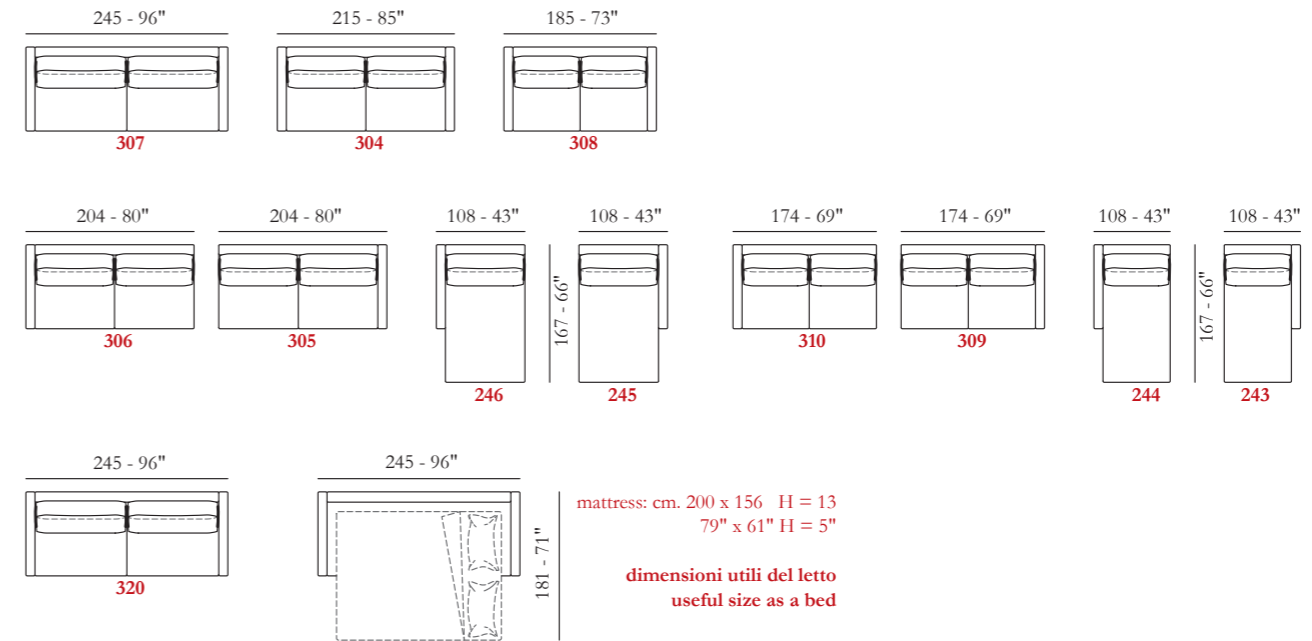

Esempi di componibilità - Sectionals examples - Exemples de compositions - Ejemplos de modularidad

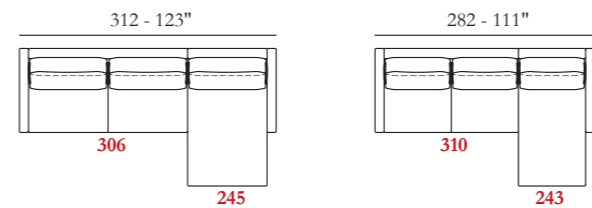

H. materasso 13 cm
H. mattress 13 cm
H. matelas 13 cm
H. colchón 13 cm



Rivestimento
Pelle/Tessuto BRACCIO (non Sfoderabile)
Tessuto (Sfoderabile)
Imbottitura
BRACCIOLI / Poliuretano espanso
SEDUTA / Poliuretano espanso
SPALLIERA / Piuma
Opzioni Cucitura a contrasto
Comfort Standard
Piedi Metallo
Struttura Telaio in legno

Coverings
Leather / Fabric ARMS (not Removable)
Fabric (Removable)
Filling
ARMS / Foam
SEAT CUSHION / Foam
BACK CUSHION / Feather
Options Contrast stitching
Comfort Standard
Legs Metal
Structure Wooden frame

Revêtement
Cuir / Tissu ACCOUDOIRS (pas Déhoussable)
Tissu (Déhoussable)
Rembourrage
ACCOUDOIRS / Mousse
ASSISE / Mousse
DOSSIER / Plumes
Options Coutures contrastées
Confort Standard
Pieds Metal
Structure Structure en bois

Revestimiento
Piel / Tela BRAZO (no Extraible)
Tela (Extraible)
Imbottitura
APOYABRAZOS / Poliuretano expandido
SENTADA / Poliuretano expandido
RESPALDO / Pluma
Opciones Costura en contraste
Confort Estándar
Pies Metal
Struttura Estructura en madera

Evelyn

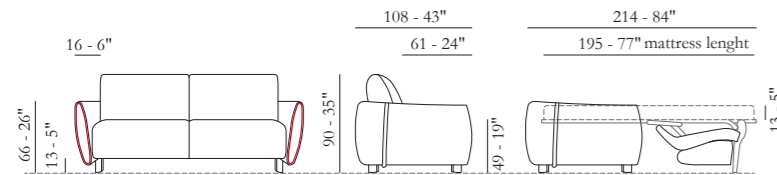

Patented model

Rolling System mechanism

Finitura piedi / Legs finishes
Finition de pieds / Acabados de pies



01 Naturale
Natural
Naturael
Naturales

02 Cillegio
Cherry
Merisier
Cerezo

03 Noce
Walnut
Noyer
Nuez

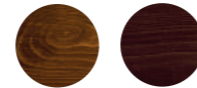

04 Noce brunito
Dark walnut
Noyer foncé
Nogal dorado

06 Wengè
Wengè
Wengé
Wengé



H. materasso 13 cm
H. mattress 13 cm
H. matelas 13 cm
H. colchón 13 cm

Gross grain colors

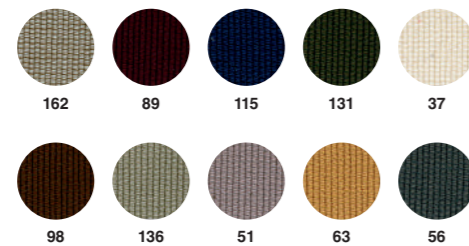

Rivestimento
Tessuto (Sfoderabile)

Imbottitura
BRACCIOLI / Poliuretano espanso
SEDUTA / Poliuretano espanso
SPALLIERA / Poliuretano espanso

Opzioni Gross grain disponibili

Comfort Standard

Piedi Legno

Finiture 01 / 02 / 03 / 04 / 06

Struttura Telaio in legno

Coverings
Fabric (Removable)

Filling
ARMS / Foam
SEAT CUSHION / Foam
BACK CUSHION / Foam

Options Gross grain available

Comfort Standard

Legs Wood

Finishing 01 / 02 / 03 / 04 / 06

Structure Wooden frame

Revêtement
Tissu (Déhoussable)

Imbottitura
ACCOUDOIRS / Mousse
ASSISE / Mousse
DOSSIER / Mousse

Options Gross grain disponible

Comfort Standard

Pieds Bois

Finition 01 / 02 / 03 / 04 / 06

Structure Structure en bois

Revestimiento
Tela (Extraible)

Imbottitura
APOYABRAZOS / Poliuretano expandido
SENTADA / Poliuretano expandido
RESPALDO / Poliuretano expandido

Opciones Gross grain disponible

Comfort Estándar

Pies Madera

Acabados 01 / 02 / 03 / 04 / 06

Struttura Estructura en madera

Flora

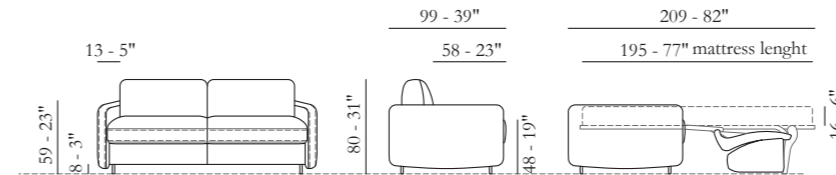

Patented model

Rolling System mechanism

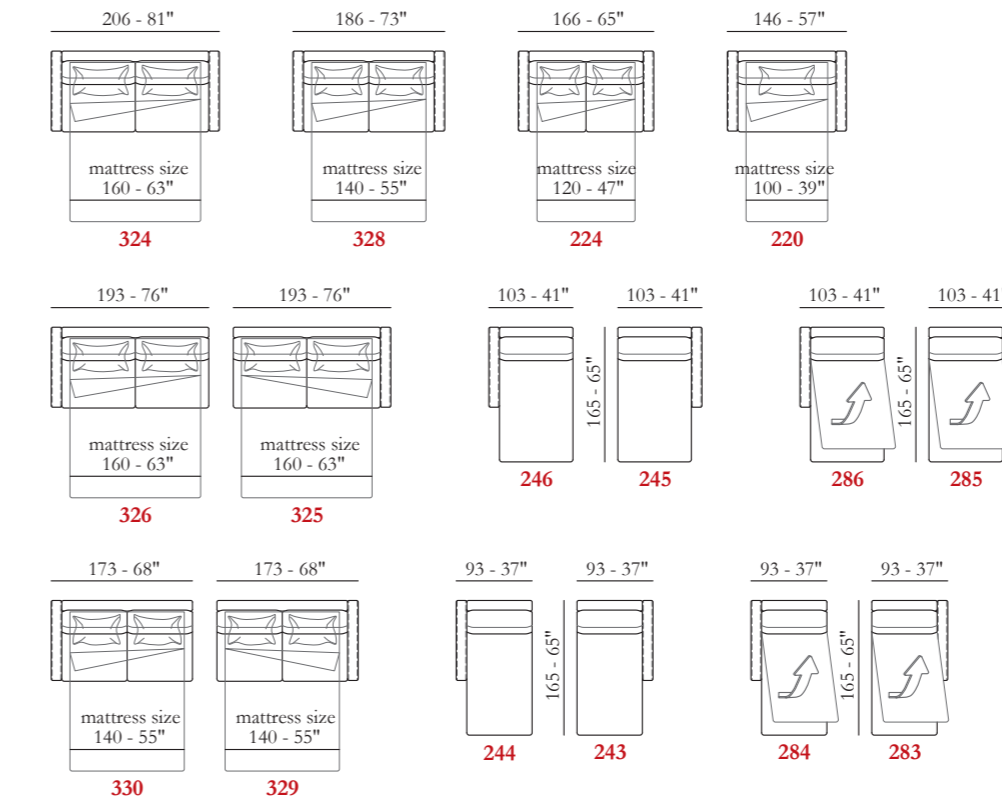

Esempi di componibilità - Sectionals examples - Exemples de compositions - Ejemplos de modularidad

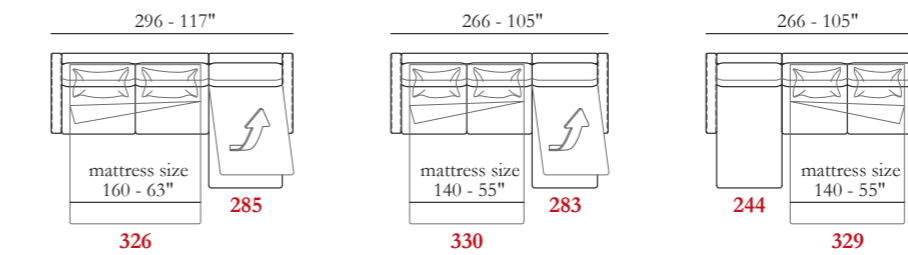

H. materasso 16 cm
H. mattress 16 cm
H. matelas 16 cm
H. colchón 16 cm

Rivestimento
Pelle BRACCIO (non Sfoderabile)
Tessuto (Sfoderabile)

Imbottitura
BRACCIOLI / Poliuretano espanso
SEDUTA / Poliuretano espanso
SPALLIERA / Poliuretano espanso

Opzioni Cucitura a contrasto

Comfort Standard

Piedi Metallo

Struttura Telaio in legno

Coverings
Leather ARMS (not Removable)
Fabric (Removable)

Filling
ARMS / Foam
SEAT CUSHION / Foam
BACK CUSHION / Foam

Options Contrast stitching

Comfort Standard

Legs Metal

Structure Wooden frame

Revêtement
Cuir ACCOUDOIRS (pas Déhoussable)
Tissu (Déhoussable)

Rembourrage
ACCOUDOIRS / Mousse
ASSISE / Mousse
DOSSIER / Mousse

Options Coutures contrastées

Comfort Standard

Pieds Metal

Structure Structure en bois

Revestimiento
Piel BRAZO (no Extraible)
Tela (Extraible)

Imbottitura
APOYABRAZOS / Poliuretano expandido
SENTADA / Poliuretano expandido
RESPALDO / Poliuretano expandido

Opciones Costura en contraste

Comfort Estándar

Pies Metal

Struttura Estructura en madera

Freddy

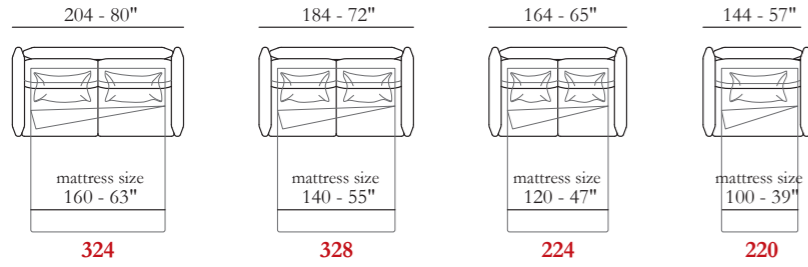
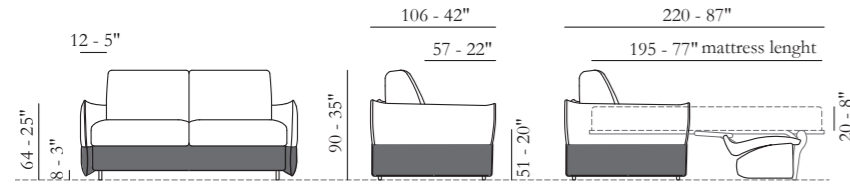

Patented model

Rolling System mechanism

George

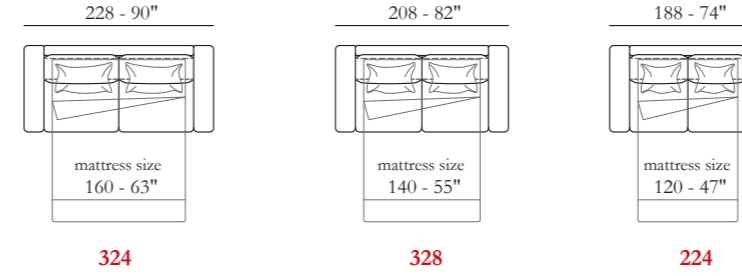
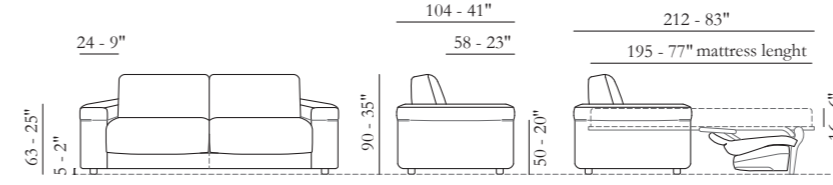

Patented model

Rolling System mechanism



H. materasso 20 cm
H. mattress 20 cm
H. matelas 20 cm
H. colchón 20 cm



H. materasso 16 cm
H. mattress 16 cm
H. matelas 16 cm
H. colchón 16 cm

Cucitura decorativa in tinta o a contrasto
Matching or contrast decorative
Coutures décoratives assorties ou contrastées
Costuras decorativas a juego y en contraste



Rivestimento
Tessuto e Pelle (Parzialmente sfoderabile)
Tessuto (Sfoderabile)
Imbottitura
BRACCIOLI / Poliuretano espanso
SEDUTA / Poliuretano espanso
SPALLIERA / Poliuretano espanso
Opzioni Dettaglio fascia in pelle
Comfort Standard
Piedi Metallo
Struttura Telaio in legno

Coverings
Fabric and Leather (Partially removable)
Fabric (Removable)
Filling
ARMS / Foam
SEAT CUSHION / Foam
BACK CUSHION / Foam
Options Leather detail
Comfort Standard
Legs Metal
Structure Wooden frame

Revêtement
Tissu et cuir (partiellement Déhoussable)
Tissu (Déhoussable)
Rembourrage
ACCOUDOIRS / Mousse
ASSISE / Mousse
DOSSIER / Mousse
Options Détail en cuir
Confort Standard
Pieds Metal
Structure Structure en bois

Revestimiento
Tela y cuero (parcialmente extraíble)
Tela (Extraíble)
Imbottitura
APOYABRAZOS / Poliuretano expandido
SENTADA / Poliuretano expandido
RESPALDO / Poliuretano expandido
Opciones Detalle de cuero
Confort Estándar
Pies Metal
Struttura Estructura en madera

Rivestimento
Tessuto (Sfoderabile)
Imbottitura
BRACCIOLI / Poliuretano espanso
SEDUTA / Poliuretano espanso
SPALLIERA / Poliuretano
Opzioni Cucitura a contrasto
Comfort Standard
Piedi Plastica
Struttura Telaio in legno

Coverings
Fabric (Removable)
Filling
ARMS / Foam
SEAT CUSHION / Foam
BACK CUSHION / Foam
Options Contrast stitching
Comfort Standard
Legs Plastic
Structure Wooden frame

Revêtement
Tissu (Déhoussable)
Rembourrage
ACCOUDOIRS / Mousse
ASSISE / Mousse
DOSSIER / Mousse
Options Coutures contrastées
Confort Standard
Pieds Plastique
Structure Structure en bois

Revestimiento
Tela (Extraíble)
Imbottitura
APOYABRAZOS / Poliuretano expandido
SENTADA / Poliuretano expandido
RESPALDO / Poliuretano
Opciones Costura en contraste
Confort Estándar
Pies Plástico
Struttura Estructura en madera

Henry

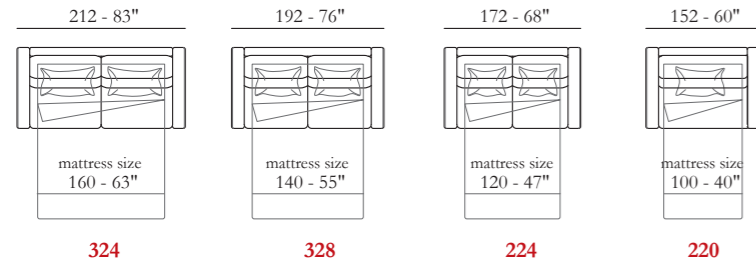
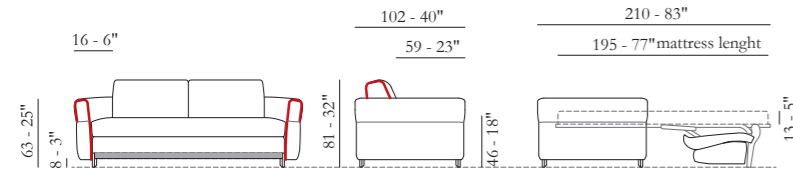

Patented model

Rolling System mechanism

Finitura piedi / Legs finishes
Finition de pieds / Acabados de pies

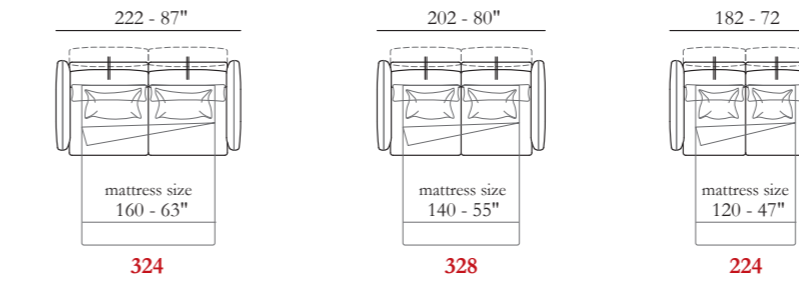
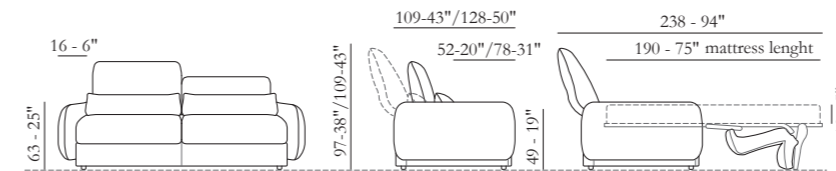
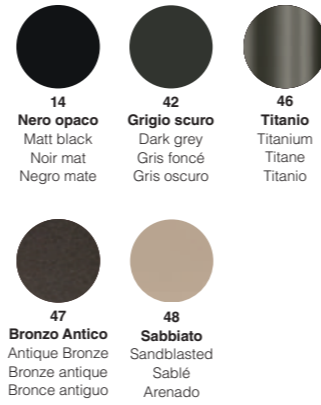

Patented model

Rolling System mechanism

Modello disponibile con rivestimento non sfoderabile

Model also available with fixed covers
Modèle disponible aussi avec coussins non déhoussable
Modelo también disponible con tapas fijas.



Gross grain colors

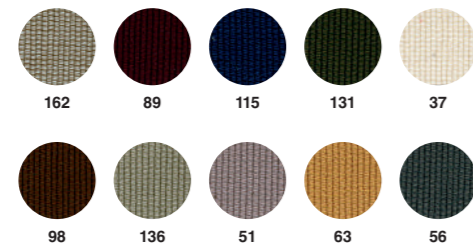

Rivestimento
Tessuto (Sfoderabile)
Imbottitura
BRACCIOLI / Poliuretano espanso
SEDUTA / Poliuretano espanso
SPALLIERA / Poliuretano espanso
Opzioni Gross grain disponibili
Comfort Standard
Piedi Metallo
Finiture 14 / 42 / 46 / 47 / 48
Struttura Telaio in legno

Coverings
Fabric (Removable)
Filling
ARMS / Foam
SEAT CUSHION / Foam
BACK CUSHION / Foam
Options Gross grain available
Comfort Standard
Legs Metal
Finishing 14 / 42 / 46 / 47 / 48
Structure Wooden frame

Revêtement
Tissu (Déhoussable)
Rembourrage
ACCOUDOIRS / Mousse
ASSISE / Mousse
DOSSIER / Mousse
Options Gross grain disponible
Confort Standard
Pieds Metal
Finition 14 / 42 / 46 / 47 / 48
Structure Structure en bois

Revestimiento
Tela (Extraíble)
Imbottitura
APOYABRAZOS / Poliuretano expandido
SENTADA / Poliuretano expandido
RESPALDO / Poliuretano expandido
Opciones Gross grain disponible
Confort Estándar
Pies Metal
Acabados 14 / 42 / 46 / 47 / 48
Struttura Estructura en madera

Rivestimento
Tessuto (Sfoderabile)
Imbottitura
BRACCIOLI / Poliuretano espanso
SEDUTA / Poliuretano espanso
SPALLIERA / Poliuretano / Fibra
Opzioni Cucitura a contrasto
Comfort Standard
Piedi Plastica
Struttura Telaio in legno

Coverings
Fabric (Removable)
Filling
ARMS / Foam
SEAT CUSHION / Foam
BACK CUSHION / Foam / Fiber
Options Coutures contrastées
Comfort Standard
Legs Plastic
Structure Wooden frame

Revêtement
Tissu (Déhoussable)
Rembourrage
ACCOUDOIRS / Mousse
ASSISE / Mousse
DOSSIER / Mousse / Fiber
Options Coutures contrastées
Confort Standard
Pieds Plastique
Structure Structure en bois

Revestimiento
Tela (Extraíble)
Imbottitura
APOYABRAZOS / Poliuretano expandido
SENTADA / Poliuretano expandido
RESPALDO / Poliuretano / Fiber
Opciones Costura en contraste
Confort Estándar
Pies Plastico
Struttura Estructura en madera



H. materasso 13 cm
H. mattress 13 cm
H. matelas 13 cm
H. colchón 13 cm



H. materasso 13 cm
H. mattress 13 cm
H. matelas 13 cm
H. colchón 13 cm

Jason

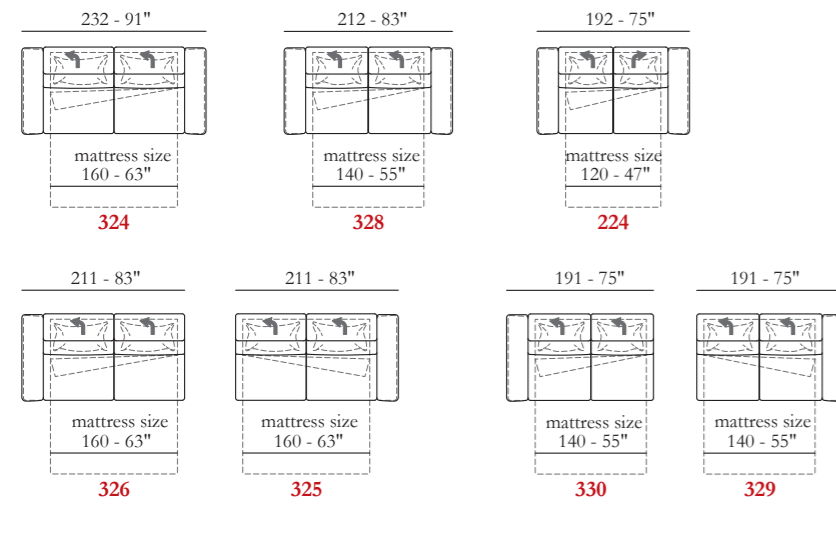
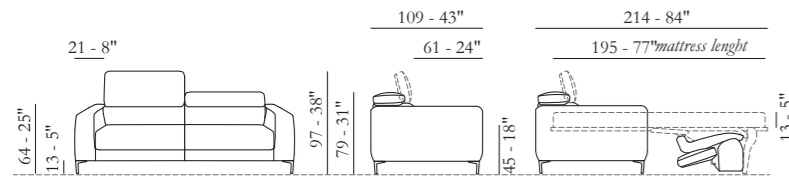

Esempi di componibilità - Sectionals examples - Exemples de compositions - Ejemplos de modularidad

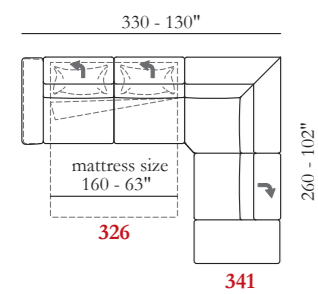

Gross grain colors

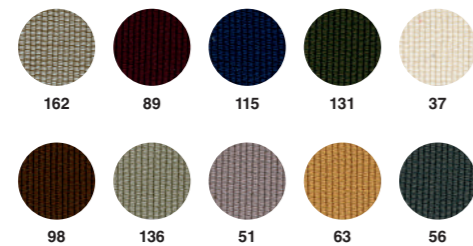

Rivestimento
Pelle / Tessuto
Imbottitura
BRACCIOLI / Poliuretano espanso
SEDUTA / Poliuretano espanso
SPALLIERA / Poliuretano espanso
Opzioni Gross Grain disponibile
Comfort Standard
Piedi Metallo
Finiture 26 / 37 / 42 / 46
Struttura Telaio in legno

Coverings
Leather / Fabric
Filling
ARMS / Foam
SEAT CUSHION / Foam
BACK CUSHION / Foam
Options Gross Grain available
Comfort Standard
Legs Metal
Finishing 26 / 37 / 42 / 46
Structure Wooden frame

Revêtement
Cuir / Tissu
Rembourrage
ACCOUDOIRS / Mousse
ASSISE / Mousse
DOSSIER / Mousse
Options Gross Grain disponible
Confort Standard
Pieds Metal
Finition 26 / 37 / 42 / 46
Structure Structure en bois

Revestimiento
Piel / Tela
Imbottitura
APOYABRAZOS / Poliuretano expandido
SENTADA / Poliuretano expandido
RESPALDO / Poliuretano expandido
Opciones Gross Grain disponible
Confort Estándar
Pies Metal
Acabados 26 / 37 / 42 / 46
Struttura Estructura en madera

Rivestimento
Tessuto (Sfoderabile)
Imbottitura
BRACCIOLI / Poliuretano espanso
SEDUTA / Poliuretano espanso
SPALLIERA / Poliuretano espanso / Fibra
Opzioni Cucitura a contrasto
Comfort Standard
Piedi Metallo
Finiture 10 / 11 / 22 / 46
Struttura Telaio in legno

Coverings
Fabric (Removable)
Filling
ARMS / Foam
SEAT CUSHION / Foam
BACK CUSHION / Foam / Fiber
Options Contrast stitching
Comfort Standard
Legs Metal
Finishing 10 / 11 / 22 / 46
Structure Wooden frame

Revêtement
Tissu (Déhoussable)
Rembourrage
ACCOUDOIRS / Mousse
ASSISE / Mousse
DOSSIER / Mousse / Fiber
Options Coutures contrastées
Confort Standard
Pieds Metal
Finition 10 / 11 / 22 / 46
Structure Structure en bois

Revestimiento
Tela (Extraíble)
Imbottitura
APOYABRAZOS / Poliuretano expandido
SENTADA / Poliuretano expandido
RESPALDO / Poliuretano expandido / Fiber
Opciones Costura en contraste
Confort Estándar
Pies Metal
Acabados 10 / 11 / 22 / 46
Struttura Estructura en madera

Laurence

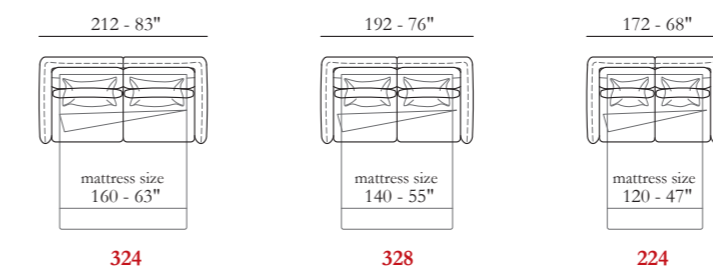
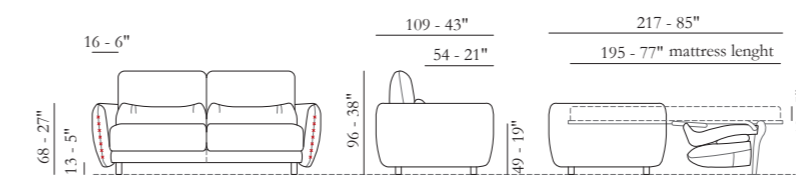

Rolling System mechanism

Finitura piedi / Legs finishes
Finition de pieds / Acabados de pies

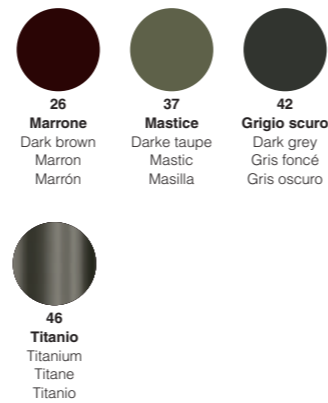

H. materasso 13 cm
H. mattress 13 cm
H. matelas 13 cm
H. colchón 13 cm



Cucitura decorativa in tinta o a contrasto
Matching or contrast decorative
Coutures décoratives assorties ou contrastées
Costuras decorativas a juego y en contraste

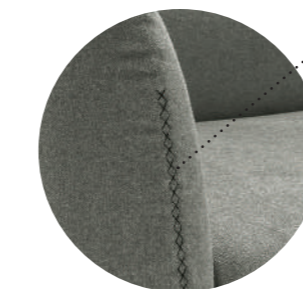

Rolling System mechanism

Finitura piedi / Legs finishes
Finition de pieds / Acabados de pies

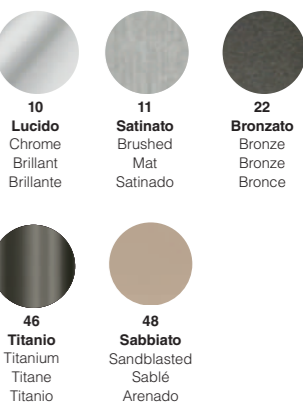

H. materasso 13 cm
H. mattress 13 cm
H. matelas 13 cm
H. colchón 13 cm



Loll

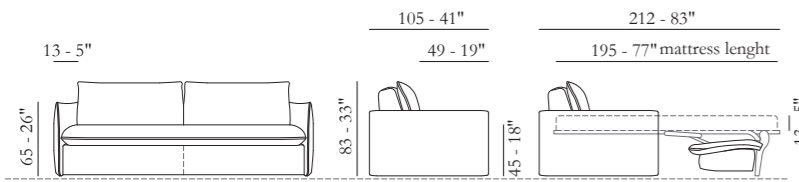

Rolling System mechanism

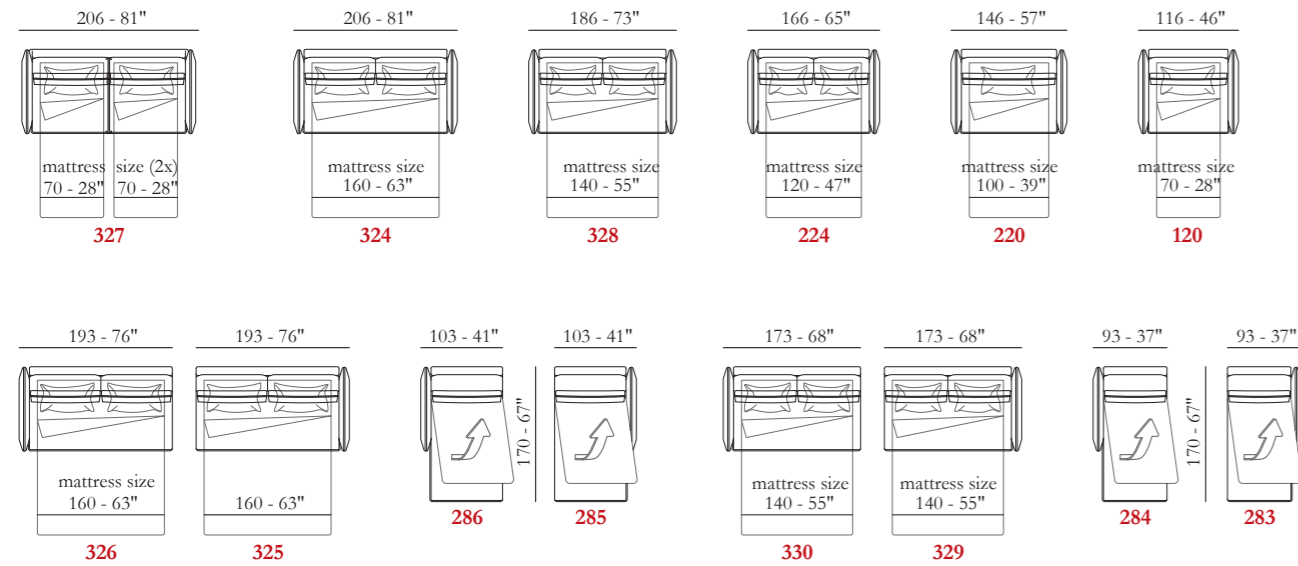

Esempi di componibilità - Sectionals examples - Exemples de compositions - Ejemplos de modularidad

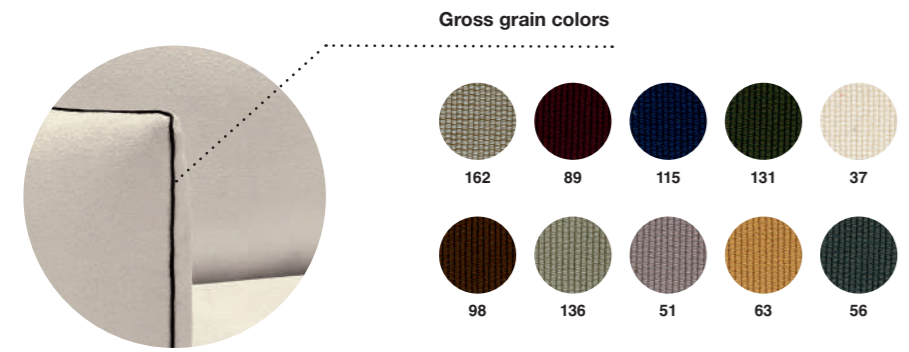
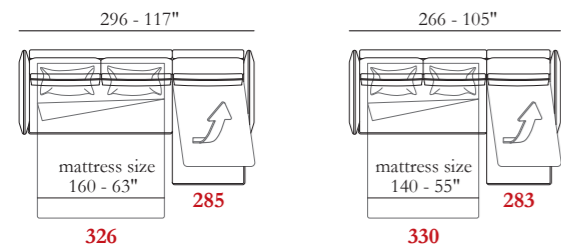

Rivestimento
Tessuto (Sfoderabile)
Imbottitura
BRACCIOLI / Poliuretano espanso
SEDUTA / Poliuretano espanso
SPALLIERA / Fibra di poliestere
Comfort Standard
Piedi Metallo
Struttura Telaio in legno

Coverings
Fabric (Removable)
Imbottitura
ARMS / Foam
SEAT CUSHION / Foam
BACK CUSHION / Fiber
Comfort Standard
Legs Metal
Structure Wooden frame

Revêtement
Tissu (Déhoussable)
Rembourrage
ACCOUDOIRS / Mousse
ASSISE / Mousse
DOSSIER / Flocons de polyester
Comfort Standard
Pieds Metal
Structure Structure en bois

Revestimiento
Tela (Extraíble)
Imbottitura
APOYABRAZOS / Poliuretano expandido
SENTADA / Poliuretano expandido
RESPALDO / Fibras de poliéster
Comfort Estándar
Pies Metal
Struttura Estructura en madera

Modello disponibile con rete a doghe in legno.
Model also available with wooden slats.
Modèle disponible aussi avec sommier à lattes
Modelo también disponible somier de lamas de madera.

Matilda

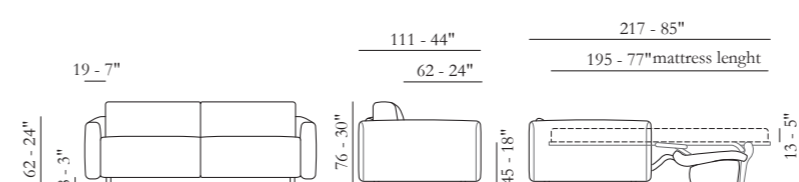

Patented model

Rolling System mechanism

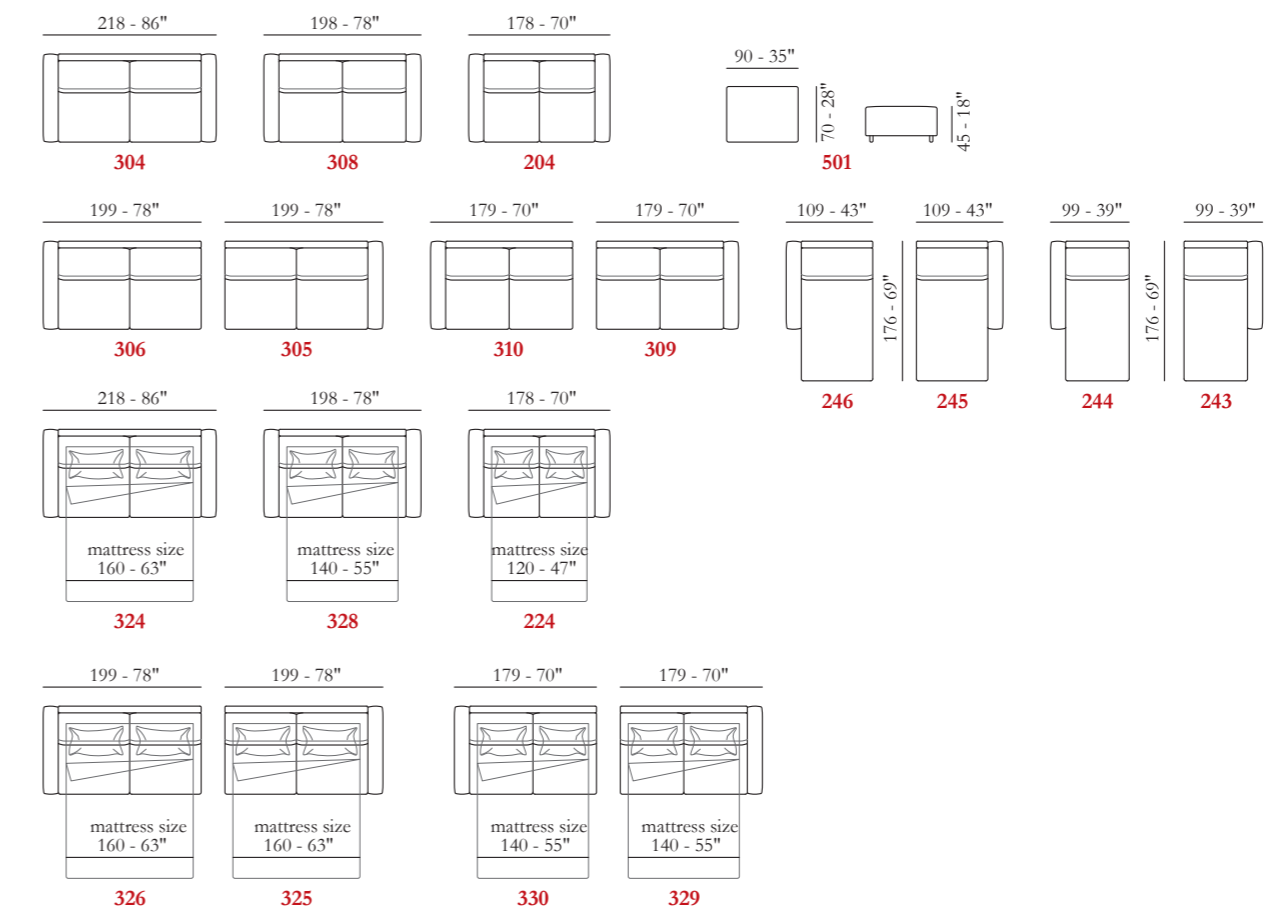

Esempi di componibilità - Sectionals examples - Exemples de compositions - Ejemplos de modularidad

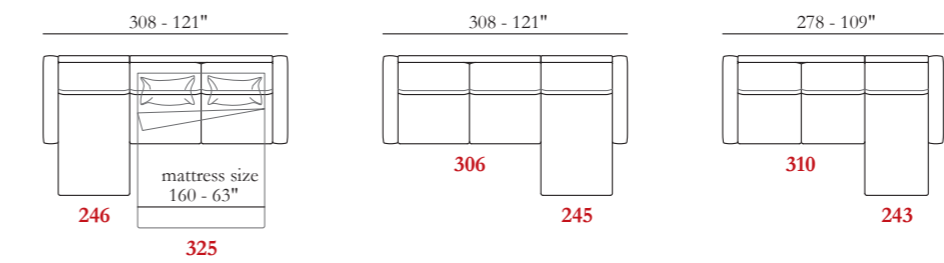

H. materasso 13 cm
H. materasso 13 cm
H. matelas 13 cm
H. colchón 13 cm



H. materasso 13 cm
H. materasso 13 cm
H. matelas 13 cm
H. colchón 13 cm



Rivestimento
Tessuto (Sfoderabile)
Imbottitura
BRACCIOLI / Poliuretano espanso
SEDUTA / Poliuretano espanso
SPALLIERA / Poliuretano espanso
Comfort Standard
Piedi Metallo
Struttura Telaio in legno

Coverings
Fabric (Removable)
Filling
ARMS / Foam
SEAT CUSHION / Foam
BACK CUSHION / Foam
Comfort Standard
Legs Metal
Structure Wooden frame

Revêtement
Tissu (Déhoussable)
Rembourrage
ACCOUDOIRS / Mousse
ASSISE / Mousse
DOSSIER / Mousse
Comfort Standard
Pieds Metal
Structure Structure en bois

Revestimiento
Tela (Extraíble)
Imbottitura
APOYABRAZOS / Poliuretano expandido
SENTADA / Poliuretano expandido
RESPALDO / Poliuretano expandido
Comfort Estándar
Pies Metal
Struttura Estructura en madera

Maya

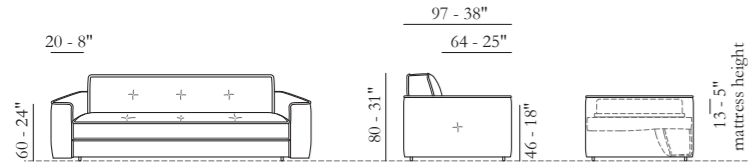

Patented model

Solo System mechanism

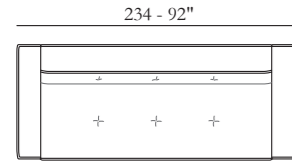

320

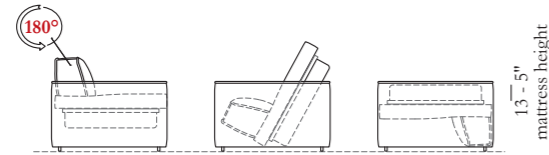

apertura sistema letto
transition to bed

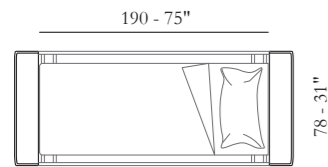

mattress: cm. 190 x 78 H = 13
75" x 31" H = 5"

dimensioni utili del letto
useful size as a bed



H. materasso 13 cm

H. mattress 13 cm
H. matelas 13 cm
H. colchón 13 cm

Altezza materasso H.

Mattress available only in D28
Matelas disponible uniquement en D28
Matelas disponibles únicamente en D28

Rivestimento

Tessuto (Sfoderabile)

Imbottitura

BRACCIOLI / Poliuretano espanso

SEDUTA / Poliuretano espanso

SPALLIERA / Poliuretano espanso

Comfort Standard

Piedi Metallo

Struttura Telaio in legno

Coverings

Fabric (Removable)

Imbottitura

ARMS / Foam

SEAT CUSHION / Foam

BACK CUSHION / Foam

Comfort Standard

Legs Metal

Structure Wooden frame

Revêtement

Tissu (Déhoussable)

Rembourrage

ACCODOIRS / Mousse

ASSISE / Mousse

DOSSIER / Mousse

Comfort Standard

Pieds Metal

Structure Structure en bois

Revestimiento

Tela (Extraible)

Imbottitura

APOYABRAZOS / Poliuretano expandido

SENTADA / Poliuretano expandido

RESPALDO / Poliuretano expandido

Comfort Estándar

Pies Metal

Struttura Estructura en madera

Rivestimento

Tessuto (Sfoderabile)

Imbottitura

BRACCIOLI / Poliuretano espanso

SEDUTA / Poliuretano espanso

SPALLIERA / Poliuretano espanso

Opzioni Cucitura a contrasto

Comfort Standard

Piedi Metallo

Finiture 14 / 42 / 46 / 47

Struttura Telaio in legno

Coverings

Fabric (Removable)

Filling

ARMS / Foam

SEAT CUSHION / Foam

BACK CUSHION / Foam

Options Coutures contrastées

Comfort Standard

Legs Metal

Finishing 14 / 42 / 46 / 47

Structure Wooden frame

Revêtement

Tissu (Déhoussable)

Rembourrage

ACCODOIRS / Mousse

ASSISE / Mousse

DOSSIER / Mousse

Options Coutures contrastées

Comfort Standard

Pieds Metal

Finition 14 / 42 / 46 / 47

Structure Structure en bois

Revestimiento

Tela (Extraible)

Imbottitura

APOYABRAZOS / Poliuretano expandido

SENTADA / Poliuretano expandido

RESPALDO / Poliuretano expandido

Opciones Costura en contraste

Comfort Estándar

Pies Metal

Acabados 14 / 42 / 46 / 47

Struttura Estructura en madera

Meryl



Patented model

Rolling System mechanism

Finitura piedi / Legs finishes

Finition de pieds / Acabados de pies



14
Nero opaco
Matt black
Noir mat
Negro mate

42
Grigio scuro
Dark grey
Gris foncé
Gris oscuro

46
Titanio
Titanium
Titane
Titanio



47
Bronzo Antico
Antique Bronze
Bronze antique
Bronce antiguo



H. materasso 13 cm

H. mattress 13 cm
H. matelas 13 cm
H. colchón 13 cm

Moon

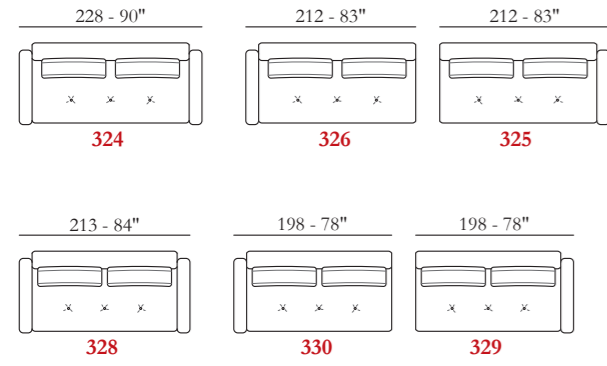
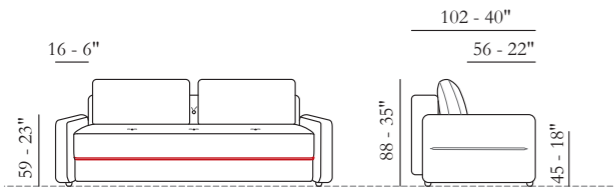

apertura sistema letto - transition to bed

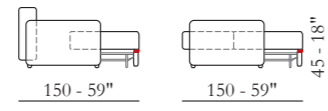
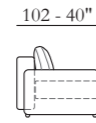

dimensione utile come letto - useful size as a bed

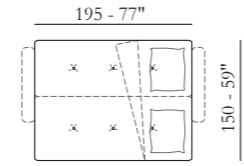

324/326/325

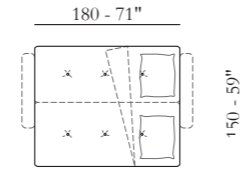

328/330/329

OPTIONAL
topper con elastici / with elastic

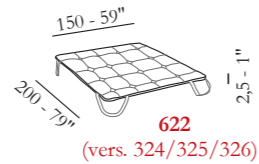

622
(vers. 324/325/326)

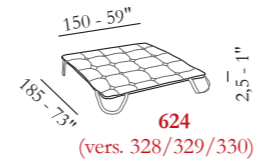

624
(vers. 328/329/330)

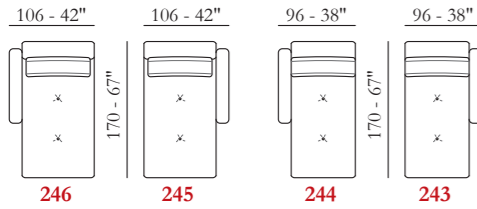

Esempi di componibilità - Sectionals examples - Exemples de compositions - Ejemplos de modularidad

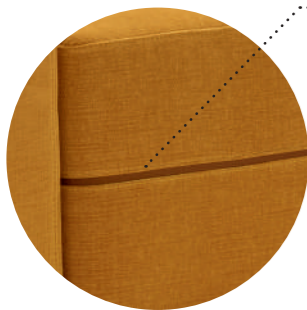
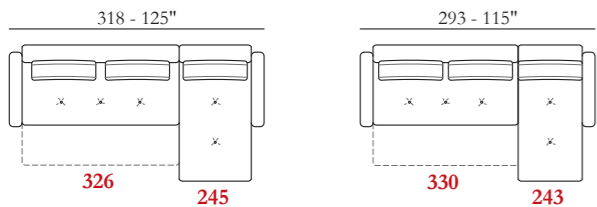

Gross grain colors

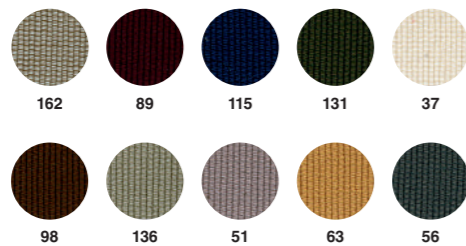

Easy Bed System
mechanism



Naomy

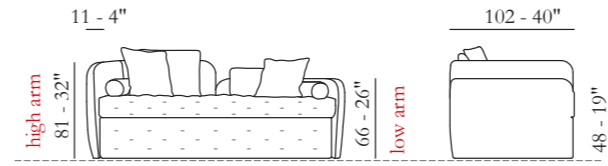

Patented model

Duo System
mechanism

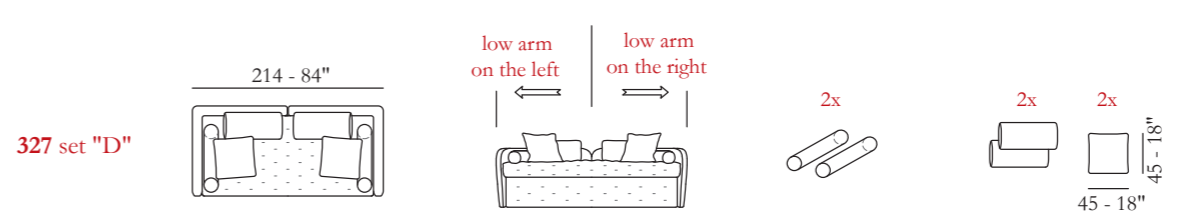
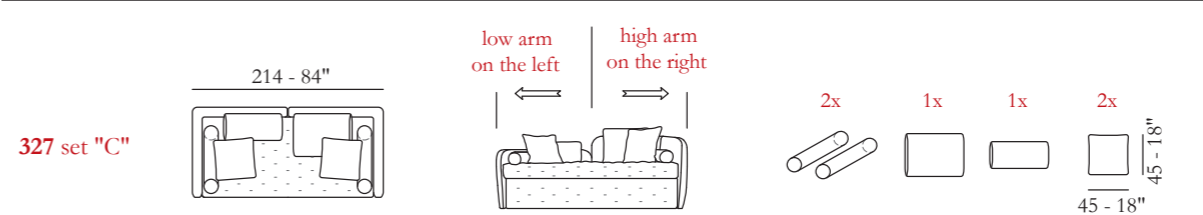
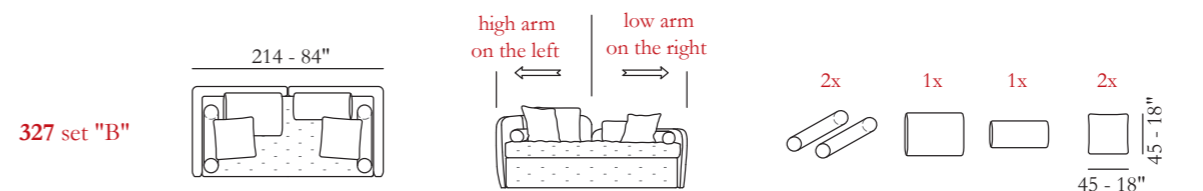
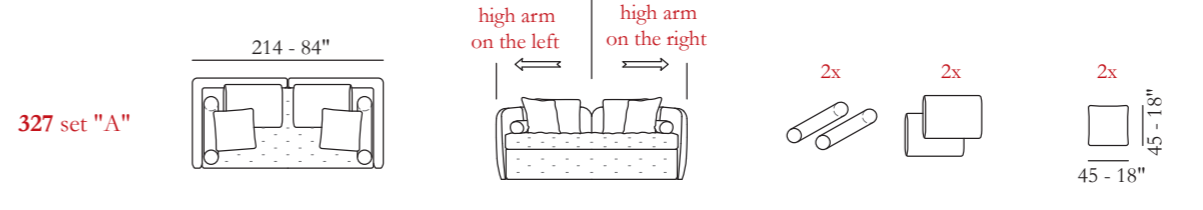

apertura sistema letto
transition to bed



mattress: cm. 190 x 88 H = 15
75" x 35" H = 6"



mattress: cm. 190 x 80 H = 15
75" x 31" H = 6"

dimensioni utili del letto
useful size as a bed



H. materasso 15 cm
H. matelas 15 cm
H. colchón 15 cm

Materasso disponibile solo in D30
Mattress available only in D30
Matelas disponible uniquement en D30
Matelas disponibles únicamente en D30

Rivestimento
Tessuto
Imbottitura
BRACCIOLI / Poliuretano espanso
SEDUTA / Poliuretano espanso
SPALLIERA / Microflock - Espanso
Opzioni Gross Grain disponibile
Comfort Standard
Piedi Plastica
Struttura Telaio in legno

Coverings
Fabric
Rembourrage
ARMS / Foam
SEAT CUSHION / Foam
BACK CUSHION / Microflock - Foam
Options Gross Grain available
Comfort Standard
Legs Plastic
Structure Wooden frame

Revêtement
Tissu
Rembourrage
ACCOUDOIRS / Mousse
ASSISE / Mousse
DOSSIER / Microflock - Mousse
Options Gross Grain disponible
Confort Standard
Pieds Plastique
Structure Structure en bois

Revestimiento
Tela
Imbottitura
APOYABRAZOS / Poliuretano expandido SENTA-
DA / Poliuretano expandido
RESPALDO / Microflock - Poliuretano expandido
Opciones Gross Grain disponible
Confort Estándar
Pies Plástico
Struttura Estructura en madera

Rivestimento
Tessuto (Sfoderabile)
Imbottitura
BRACCIOLI / Poliuretano espanso
SEDUTA / Poliuretano espanso
SPALLIERA / Piuma
Comfort Standard
Opzioni Cucitura a contrasto
Piedi Metallo
Struttura Telaio in legno

Coverings
Fabric (Removable)
Imbottitura
ARMS / Foam
SEAT CUSHION / Foam
BACK CUSHION / Feather
Comfort Standard
Options Contrast stitching
Legs Metal
Structure Wooden frame

Revêtement
Tissu (Déhoussable)
Rembourrage
ACCOUDOIRS / Mousse
ASSISE / Mousse
DOSSIER / Plumes
Options Coutures contrastées
Confort Standard
Pieds Metal
Structure Structure en bois

Revestimiento
Tela (Extraible)
Imbottitura
APOYABRAZOS / Poliuretano expandido
SENTADA / Poliuretano expandido
RESPALDO / Piuma
Opciones Costura en contraste
Confort Estándar
Pies Metal
Struttura Estructura en madera

Nathan

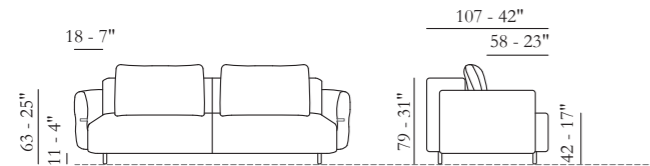

Patented model

Easy Bed System mechanism

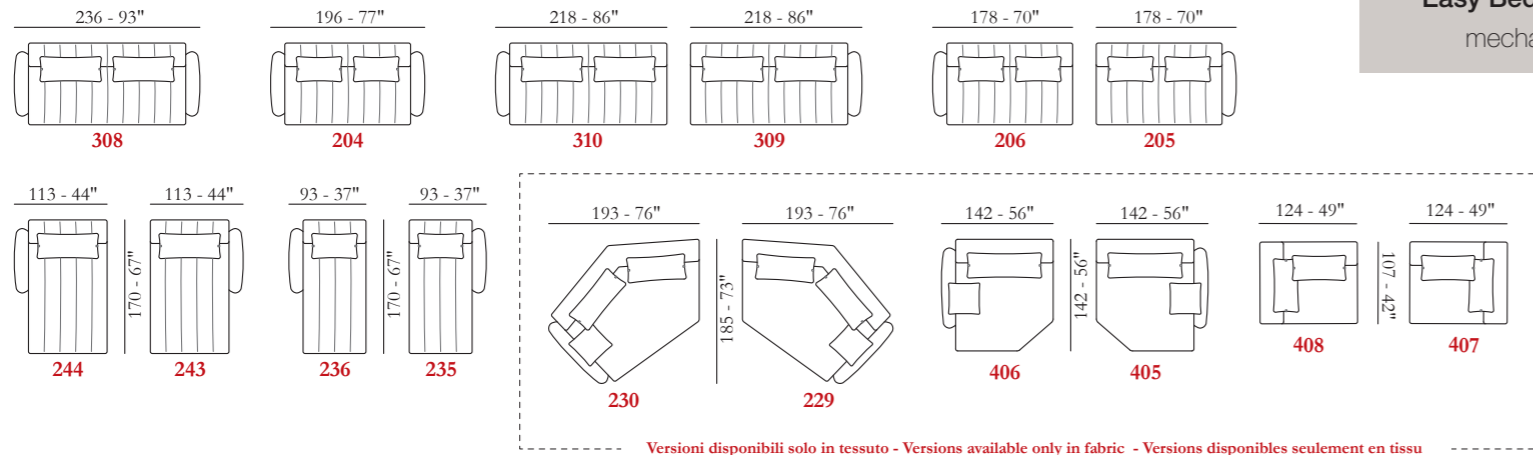

Versioni disponibili solo in tessuto - Versions available only in fabric - Versions disponibles seulement en tissu

Versioni sistema letto - Sofabed versions

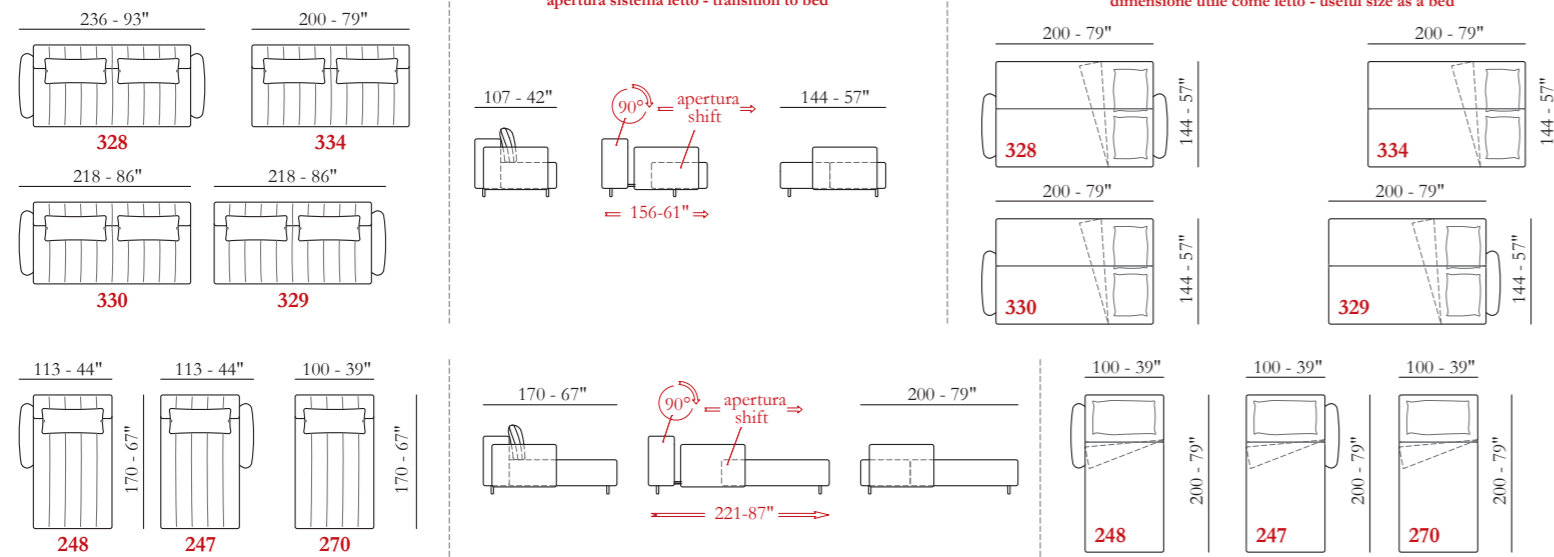

apertura sistema letto - transition to bed

dimensione utile come letto - useful size as a bed

OPTIONAL
contenitore all'interno del meccanismo letto
ordinabile sulle versioni
storage system inside bed mechanism only
available for the follinw items:
328 - 329/330 - 334

OPTIONAL
Topper con elastici agli spigoli
Elasticed Topper

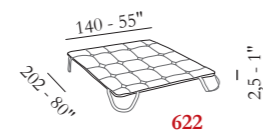
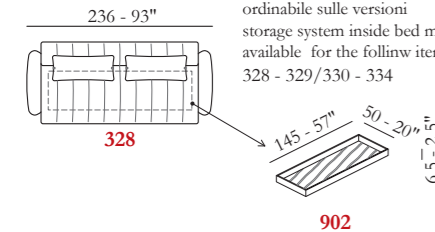

Rivestimento

Pelle / Tessuto (Sfoderabile)

Imbottitura

BRACCIOLI / Poliuretano espanso

SEDUTA / Poliuretano espanso

SPALLIERA / Fibra Piuma - Espanso

Opzioni Dettaglio fascia in pelle

Comfort Standard

Piedi Metallo

Struttura Telaio in legno e metallo

Coverings

Leather / fabric (Removable)

Filling

ARMS / Foam

SEAT CUSHION / Foam

BACK CUSHION / Fiber - Foam

Options Leather detail

Comfort Standard

Legs Metal

Structure Iron and wooden frame

Revêtement

Cuir / Tissu (Déhoussable)

Rembourrage

ACCOUDOIRS / Mousse

ASSISE / Mousse

DOSSIER / Fiber - Mousse

Options Détail en cuir

Confort Standard

Pieds Metal

Structure Structure en bois et fer

Revestimiento

Piel / Tela (Extraible)

Imbottitura

APOYABRAZOS / Poliuretano expandido

SENTADA / Poliuretano expandido

RESPALDO / Fiber - Poliuretano expandido

Opciones Detalle de cuero

Confort Estándar

Pies Metal

Struttura Estructura en madera y hierro

Nathan



Patented model

Easy Bed System mechanism

Esempi di componibilità - Sectionals examples - Exemples de compositions - Ejemplos de modularidad

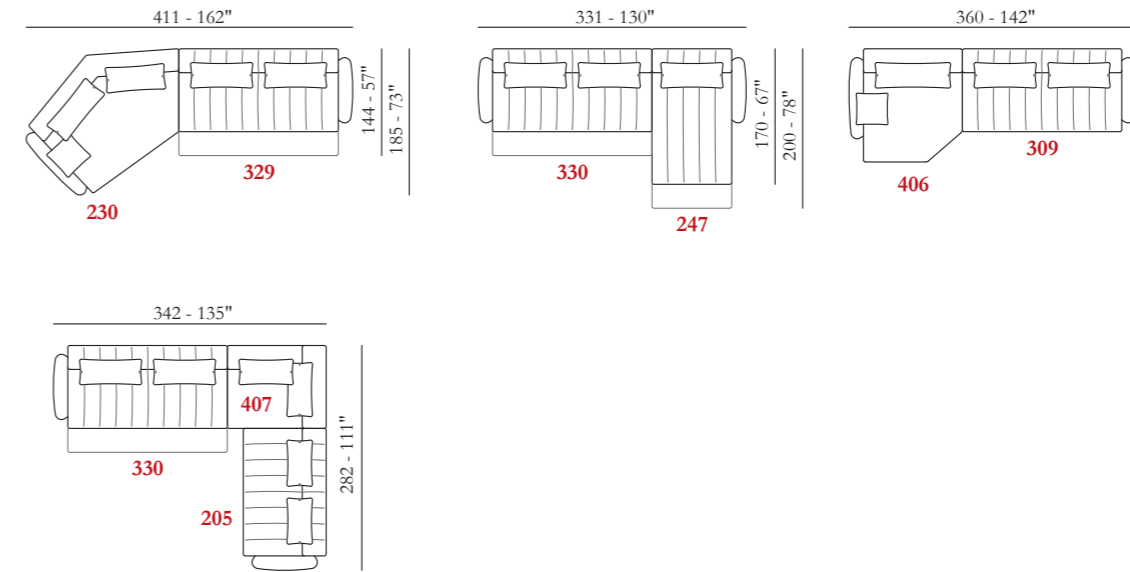

Otto

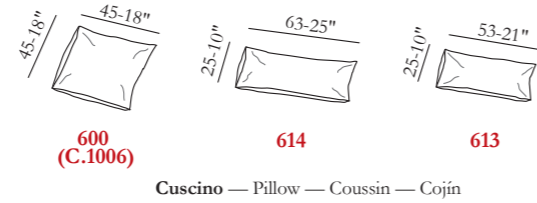
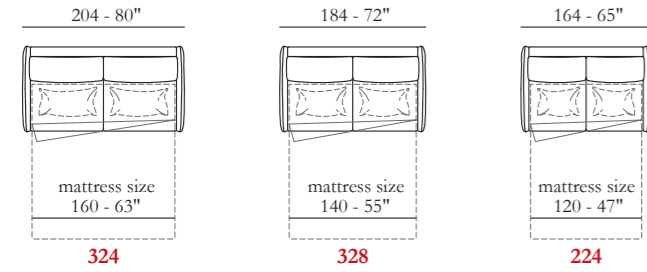
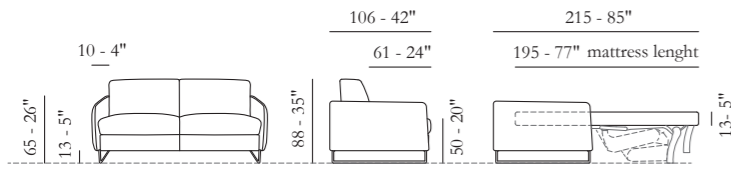

Cuscino — Pillow — Coussin — Cojín

Rolling System mechanism

Finitura piedi / Legs finishes

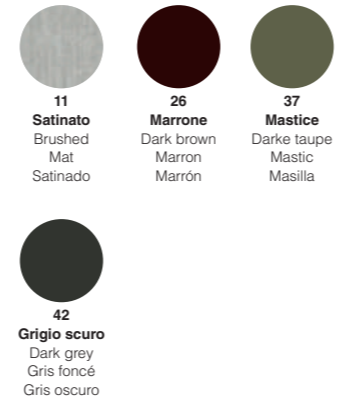

Rivestimento
Pelle / Tessuto
Imbottitura
BRACCIOLI / Poliuretano espanso
SEDUTA / Poliuretano espanso
SPALLIERA / Poliuretano espanso
Opzioni Gross Grain disponibile
Comfort Standard
Piedi Metallo
Finiture 11 / 26 / 37 / 42
Struttura Telaio in legno

Coverings
Leather / Fabric
Filling
ARMS / Foam
SEAT CUSHION / Foam
BACK CUSHION / Foam
Options Gross Grain available
Comfort Standard
Legs Metal
Finishing 11 / 26 / 37 / 42
Structure Wooden frame

Revêtement
Cuir / Tissu
Rembourrage
ACCOUDOIRS / Mousse
ASSISE / Mousse
DOSSIER / Mousse
Options Gross Grain disponible
Confort Standard
Pieds Metal
Finition 11 / 26 / 37 / 42
Structure Structure en bois

Revestimiento
Piel / Tela
Imbottitura
APOYABRAZOS / Poliuretano expandido
SENTADA / Poliuretano expandido
RESPALDO / Poliuretano expandido
Opciones Gross Grain disponible
Confort Estándar
Pies Metal
Acabados 11 / 26 / 37 / 42
Struttura Estructura en madera

Paul

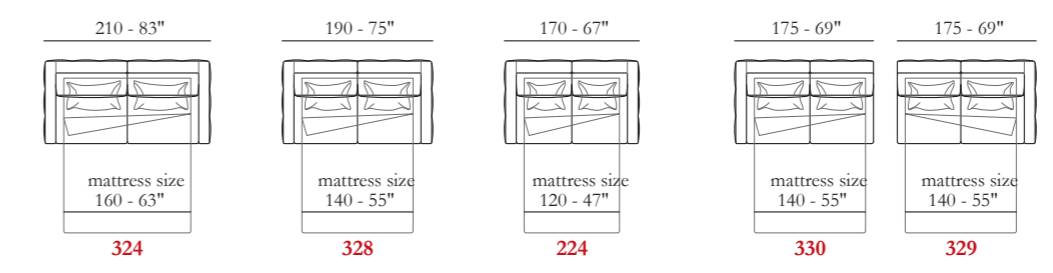
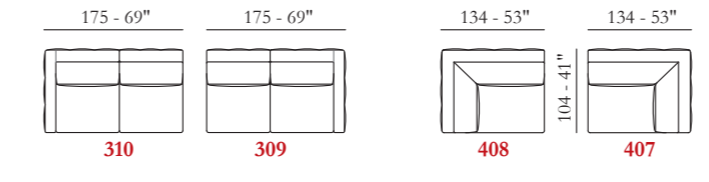
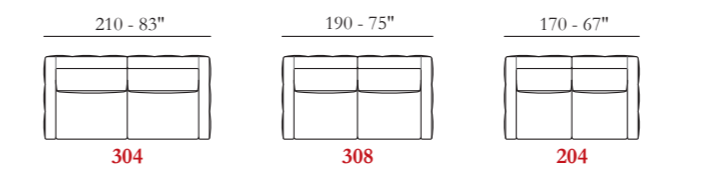
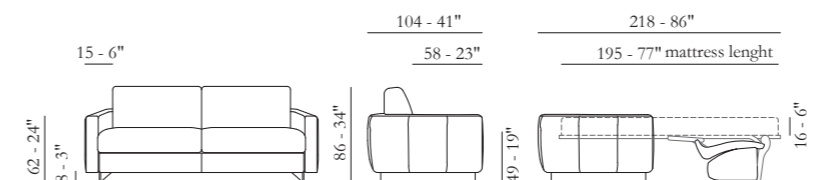

Esempi di componibilità - Sectionals examples - Exemples de compositions - Ejemplos de modularidad

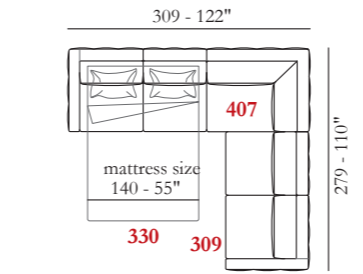

Rolling System mechanism

Finitura piedi / Legs finishes

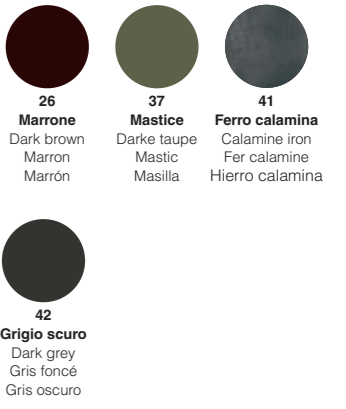

Rivestimento
Piel / Tela parcialmente desfundable
Imbottitura
APOYABRAZOS / Poliuretano expandido
SENTADA / Poliuretano expandido
RESPALDO / Poliuretano expandido
Opciones Costura en contraste
Confort Estándar
Pies Metal
Acabados 26 / 37 / 41 / 42
Struttura Estructura en madera



H. materasso 13 cm
H. mattress 13 cm
H. matelas 13 cm
H. colchón 13 cm



H. materasso 16 cm
H. mattress 16 cm
H. matelas 16 cm
H. colchón 16 cm

Gross grain colors

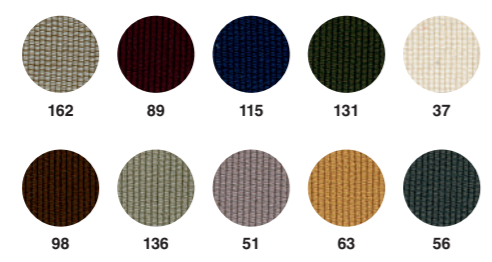

Penelope

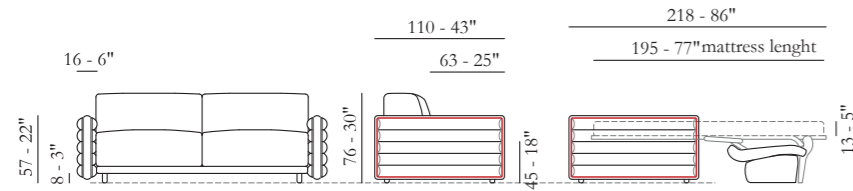

Patented model

Rolling System mechanism

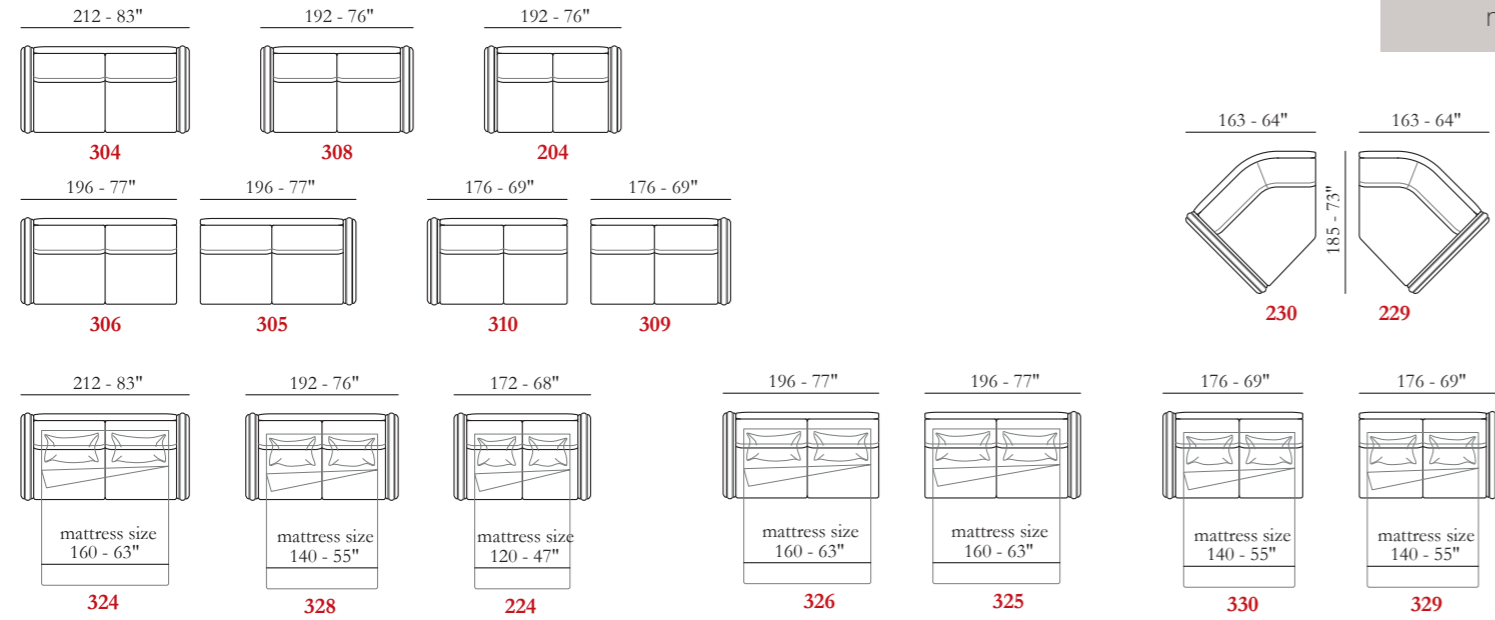

Esempi di componibilità - Sectionals examples - Exemples de compositions - Ejemplos de modularidad

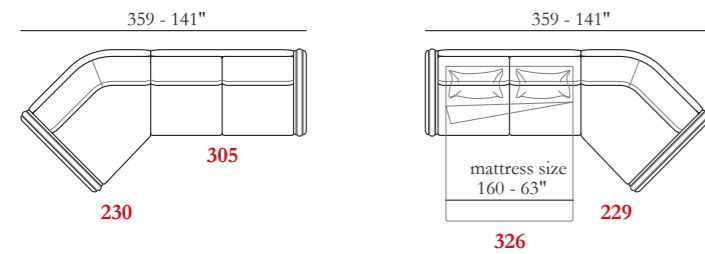

H. materasso 13 cm
H. mattress 13 cm
H. matelas 13 cm
H. colchón 13 cm

Gross grain colors

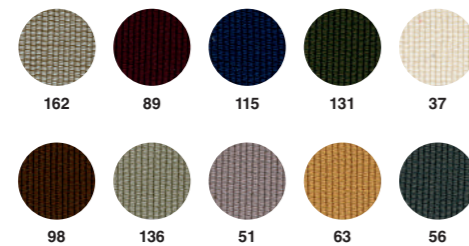

Rivestimento
Pelle/Tessuto BRACCIO (non Sfoderabile)
Tessuto (Sfoderabile)
Imbottitura
BRACCIOLI / Poliuretano espanso
SEDUTA / Poliuretano espanso
SPALLIERA / Poliuretano espanso
Opzioni Gross Grain disponibile
Comfort Standard
Piedi Metallo
Struttura Telaio in legno

Coverings
Leather / Fabric ARMS (not Removable) Fabric (Removable)
Filling
ARMS / Foam
SEAT CUSHION / Foam
BACK CUSHION / Foam
Options Gross grain available
Comfort Standard
Legs Metal
Structure Wooden frame

Revêtement
Cuir / Tissu ACCOUDOIRS (pas Déhoussable)
Tissu (Déhoussable)
Rembourrage
ACCOUDOIRS / Mousse
ASSISE / Mousse
DOSSIER / Mousse
Options Gross Grain disponible
Comfort Standard
Pieds Metal
Structure Structure en bois

Revestimiento
Piel / Tela APOYABRAZOS (no Extraible)
Tela (Extraible)
Imbottitura
APOYABRAZOS / Poliuretano expandido
SENTADA / Poliuretano expandido
RESPALDO / Poliuretano expandido
Opciones Gross Grain disponible
Comfort Estándar
Pies Metal
Struttura Estructura en madera

Rivestimento
Tessuto (Sfoderabile)
Imbottitura
BRACCIOLI / Poliuretano espanso
SEDUTA / Poliuretano espanso
SPALLIERA / Fibra di poliestere
Comfort Standard
Piedi Metallo
Struttura Telaio in legno

Coverings
Fabric (Removable)
Imbottitura
ARMS / Foam
SEAT CUSHION / Foam
BACK CUSHION / Fiber
Comfort Standard
Legs Metal
Structure Wooden frame

Revêtement
Tissu (Déhoussable)
Rembourrage
ACCOUDOIRS / Mousse
ASSISE / Mousse
DOSSIER / Flocons de polyester
Comfort Standard
Pieds Metal
Structure Structure en bois

Revestimiento
Tela (Extraible)
Imbottitura
APOYABRAZOS / Poliuretano expandido
SENTADA / Poliuretano expandido
RESPALDO / Fibras de poliéster
Comfort Estándar
Pies Metal
Struttura Estructura en madera

Perry

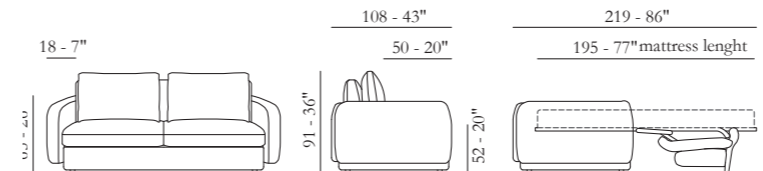

Patented model

Rolling System mechanism

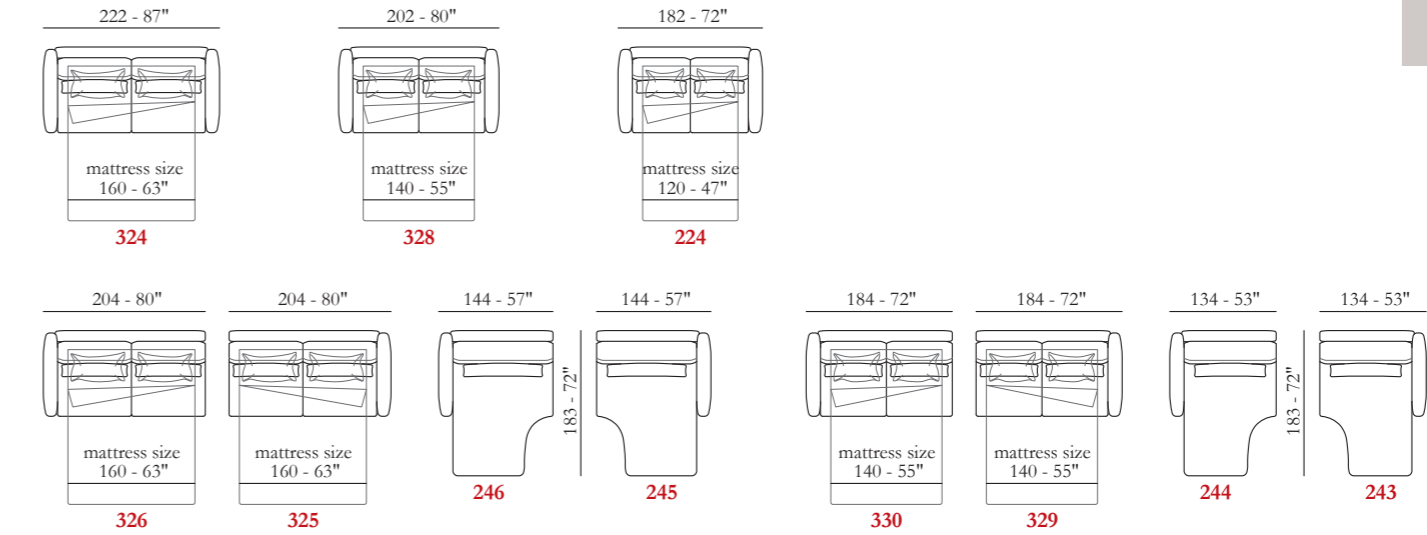

Esempi di componibilità - Sectionals examples - Exemples de compositions - Ejemplos de modularidad

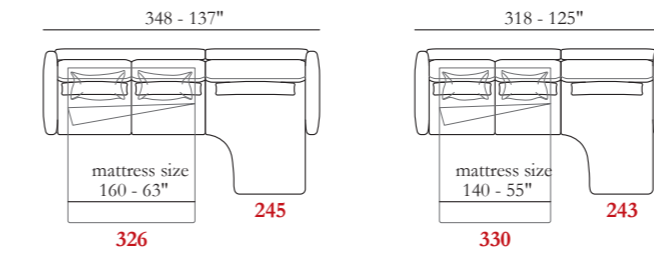

H. materasso 16 cm
H. mattress 16 cm
H. matelas 16 cm
H. colchón 16 cm

Violet

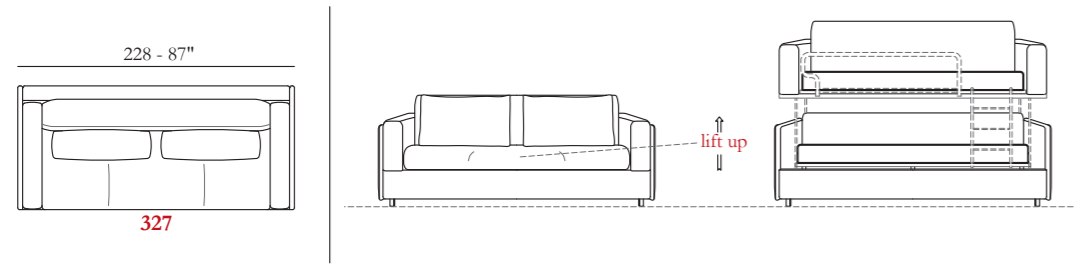
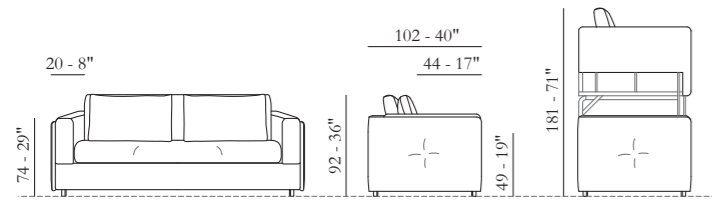

Go Up System
mechanism

apertura sistema letto
transition to bed



both mattress: cm. 190 x 78 H = 16
75" x 31" H = 6"



dimensioni utili del letto
useful size as a bed

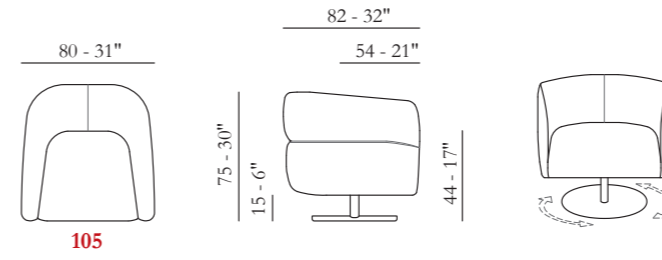

105

Dora



Finitura piedi / Legs finishes
Finition de pieds / Acabados de pies

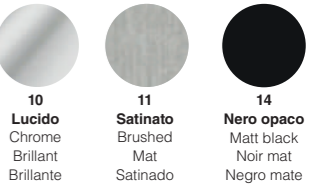

H. materasso 16 cm
H. mattress 16 cm
H. matelas 16 cm
H. colchón 16 cm

Materasso disponibile solo in D30
Mattress available only in D30
Matelas disponible uniquement en D30
Matelas disponibles únicamente en D30

Rivestimento
Tessuto (Sfoderabile)
Imbottitura
BRACCIOLI / Poliuretano espanso
SEDUTA / Poliuretano espanso
SPALLIERA / Fibra di poliestere
Comfort Standard
Piedi Metallo
Struttura Telaio in legno

Coverings
Fabric (Removable)
Imbottitura
ARMS / Foam
SEAT CUSHION / Foam
BACK CUSHION / Fiber
Comfort Standard
Legs Metal
Structure Wooden frame

Revêtement
Tissu (Déhoussable)
Rembourrage
ACCOUDOIRS / Mousse
ASSISE / Mousse
DOSSIER / Flocons de polyester
Comfort Estándar
Pieds Metal
Structure Structure en bois

Revestimiento
Tela (Extraible)
Imbottitura
APOYABRAZOS / Poliuretano expandido
SENTADA / Poliuretano expandido
RESPALDO / Fibras de poliéster
Comfort Estándar
Pies Metal
Struttura Estructura en madera

Rivestimento
Pelle / Tessuto
Imbottitura
BRACCIOLI / Poliuretano espanso
SEDUTA / Poliuretano espanso
SPALLIERA / Poliuretano espanso
Opzioni Cucitura a contrasto
Comfort Standard
Piedi Metallo
Finiture 10 / 11 / 14 / 48
Struttura Telaio in legno

Coverings
Leather / Fabric
Filling
ARMS / Foam
SEAT CUSHION / Foam
BACK CUSHION / Foam
Options Contrast stitching
Comfort Standard
Legs Metal
Finishing 10 / 11 / 14 / 48
Structure Wooden frame

Revêtement
Cuir / Tissu
Rembourrage
ACCOUDOIRS / Mousse
ASSISE / Mousse
DOSSIER / Mousse
Options Coutures contrastées
Comfort Standard
Pieds Metal
Finition 10 / 11 / 14 / 48
Structure Structure en bois

Revestimiento
Piel / Tela
Imbottitura
APOYABRAZOS / Poliuretano expandido
SENTADA / Poliuretano expandido
RESPALDO / Poliuretano expandido
Opciones Costura en contraste
Comfort Estándar
Pies Metal
Acabados 10 / 11 / 14 / 48
Struttura Estructura en madera

Alice

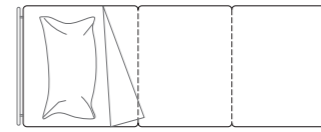
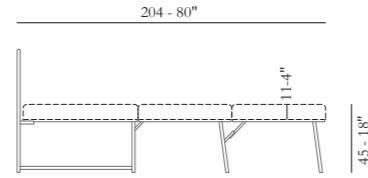
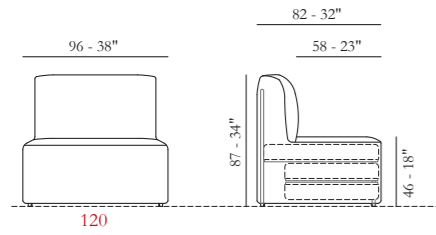

cm. 200 x 80 H = 11
79" x 31" H = 4"

dimensioni utili del letto
useful size as a bed



Rivestimento
Tessuto (Sfoderabile)

Coverings
Fabric (Removable)

Revêtement
Tissu (Déhoussable)

Revestimiento
Tela (Extraíble)

Olivia

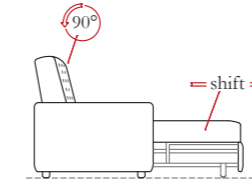
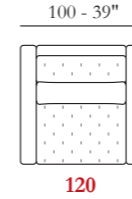
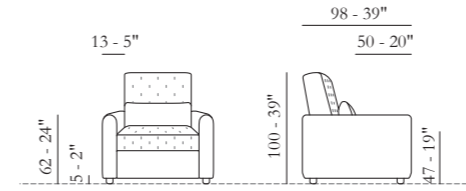

*172 - 68"
*chaise longue arrangement

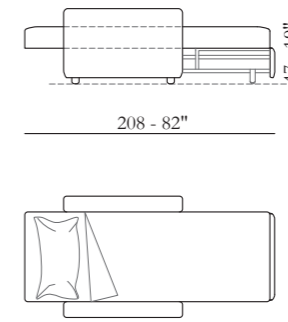

apertura sistema letto
transition to bed

cm. 202 x 74
in. 80" x 29"

dimensioni utili del letto
useful size as a bed



Rivestimento
Tessuto
Imbottitura
BRACCIOLI / Poliuretano espanso
SEDUTA / Poliuretano espanso
SPALLIERA / Fibra di poliester
Comfort Standard
Piedi Plastica
Struttura Telaio in legno

Coverings
Fabric
Imbottitura
ARMS / Foam
SEAT CUSHION / Foam
BACK CUSHION / Fiber
Comfort Standard
Legs Plastic
Structure Wooden frame

Revêtement
Tissu
Rembourrage
ACCOUDOIRS / Mousse
ASSISE / Mousse
DOSSIER / Flocons de polyester
Comfort Standard
Pieds Plastic
Structure Structure en bois

Revestimiento
Tela
Imbottitura
APOYABRAZOS / Poliuretano expandido
SENTADA / Poliuretano expandido
RESPALDO / Fibras de poliéster
Comfort Estándar
Pies Plastic
Struttura Estructura en madera

Pio

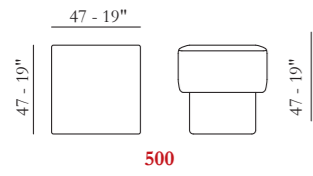

500

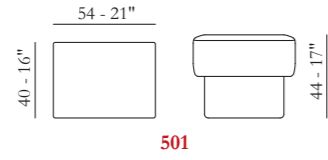

501

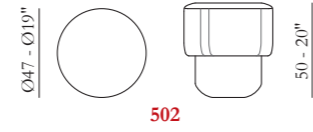

502

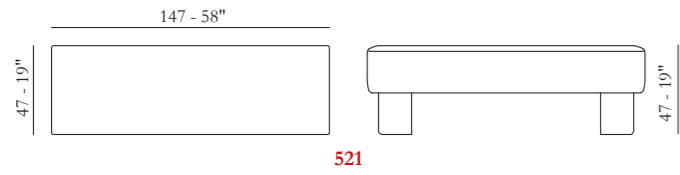

521



501

502

500

Cucitura decorativa in tinta o a contrasto
 Matching or contrast decorative
 Coutures décoratives assorties ou contrastées
 Costuras decorativas a juego y en contraste

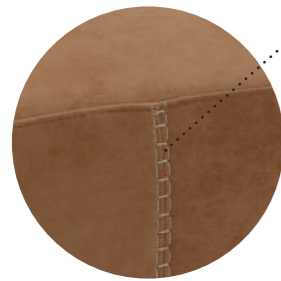

Rivestimento

Pelle / Tessuto

Imbottitura

SEDUTA / Poliuretano espanso

Opzioni Cucitura decorativa a contrasto

Comfort Standard

Struttura Telaio in legno

Coverings

Leather / Fabric

Filling

SEAT CUSHION / Foam

Options Contrast decorative stitching

Comfort Standard

Structure Wooden frame

Revêtement

Cuir / Tissu

Rembourrage

ASSISE / Mousse

Options Coutures décoratives contrastées

Confort Standard

Structure Structure en bois

Revestimiento

Piel / Tela

Imbottitura

SENTADA / Poliuretano expandido

Opciones Costuras decorativas en contraste

Confort Estándar

Struttura Estructura en madera

Rivestimento

Pelle / Tessuto

Imbottitura

SEDUTA / Poliuretano espanso

Comfort Standard

Struttura Telaio in legno

Coverings

Leather / Fabric

Filling

SEAT CUSHION / Foam

Comfort Standard

Structure Wooden frame

Revêtement

Cuir / Tissu

Rembourrage

ASSISE / Mousse

Confort Standard

Structure Structure en bois

Revestimiento

Piel / Tela

Imbottitura

SENTADA / Poliuretano expandido

Confort Estándar

Struttura Estructura en madera

Ugo

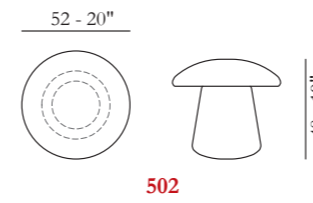

502

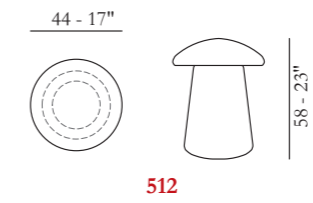

512

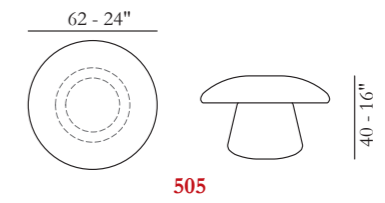

505



502

505

512

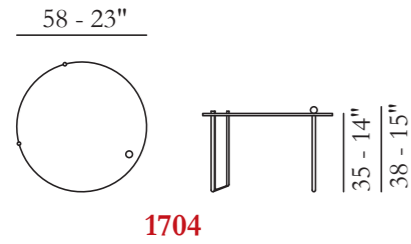

1704

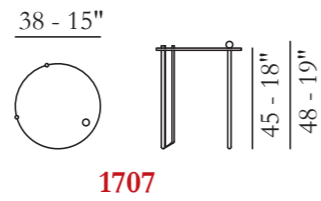

1707

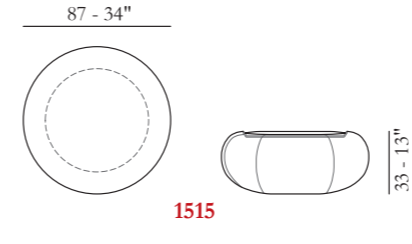

1515

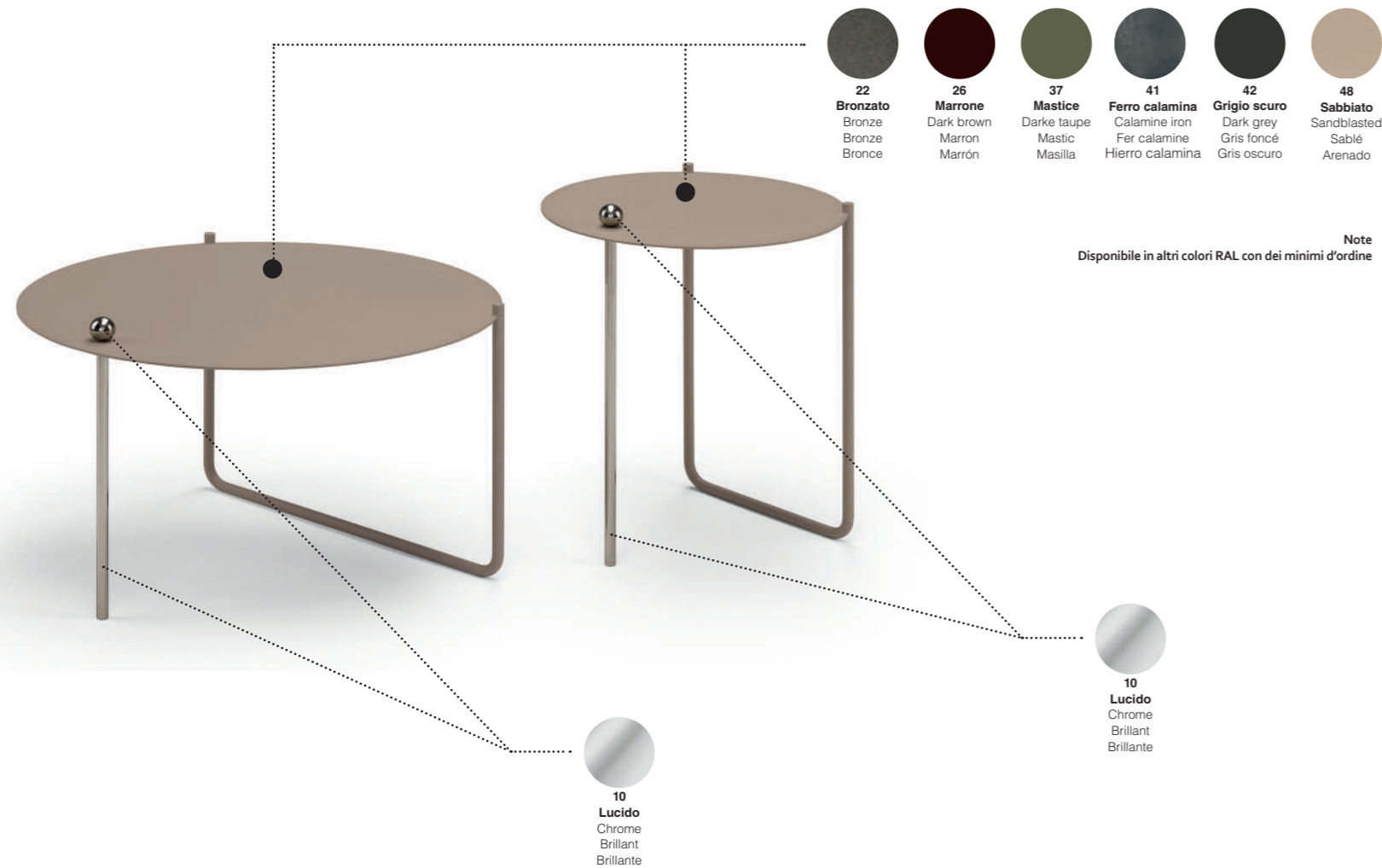

Note
Disponibile in altri colori RAL con dei minimi d'ordine

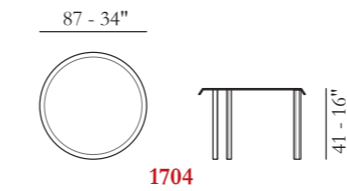

1704

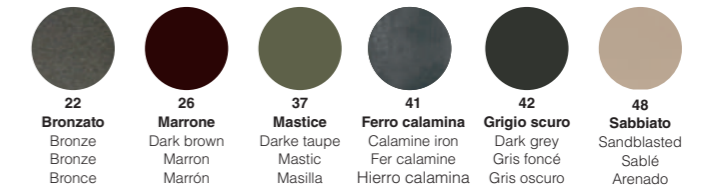
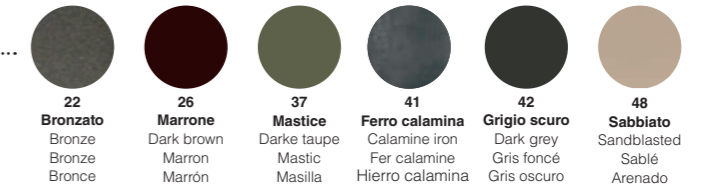
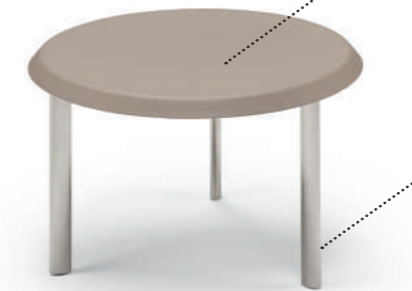

Rivestimento
Pelle / Tessuto
Imbottitura
Poliuretano espanso
Struttura Telaio in legno

Coverings
Leather / Fabric
Filling
Foam
Structure Wooden frame

Revêtement
Cuir / Tissu
Rembourrage
Mousse
Structure Structure en bois

Revestimiento
Piel / Tela
Imbottitura
Poliuretano expandido
Struttura Estructura en madera

Gigi

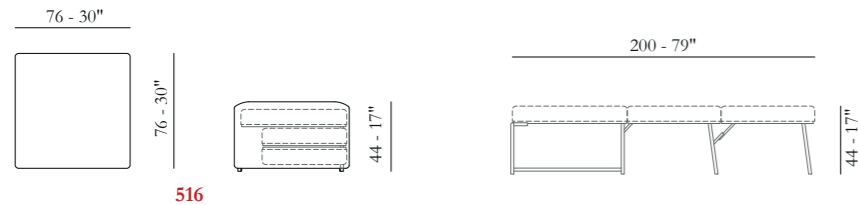

516

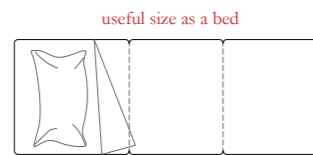

useful size as a bed
cm. 200 x 76 H = 11
79" x 30" H = 4"

H. materasso 11 cm
H. mattress 11 cm
H. matelas 11 cm
H. colchón 11 cm

Materasso disponibile solo in D28
Mattress available only in D28
Matelas disponible uniquement en D28
Matelas disponibles únicamente en D28



Rivestimento
Tessuto (Sfoderabile)

Coverings
Fabric (Removable)

Revêtement
Tissu (Déhoussable)

Revestimiento
Tela (Extraíble)

Teo

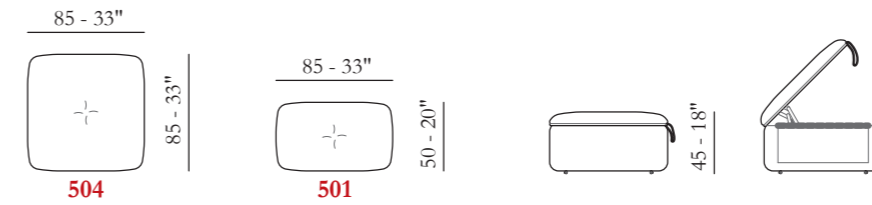

504

501



Rivestimento
Pelle / Tessuto
Imbottitura
SEDUTA / Poliuretano espanso
Comfort Standard
Struttura Telaio in legno

Coverings
Leather / Fabric
Filling
SEAT CUSHION / Foam
Comfort Standard
Structure Wooden frame

Revêtement
Cuir / Tissu
Rembourrage
ASSISE / Mousse
Comfort Standard
Structure Structure en bois

Revestimiento
Piel / Tela
Imbottitura
SENTADA / Poliuretano expandido
Comfort Estándar
Struttura Estructura en madera

Mafalda



Plaid
Dim. 130x170 cm
Comp. 70% CO - 20% PC
4% -PL 3% PA - 3% VI

Sistemi Letto - Sleeping System

I nostri sistemi letto sono pensati per rendere il divano letto un'esperienza funzionale e piacevole, adatta a ogni esigenza. Dai meccanismi facili e intuitivi alle configurazioni flessibili, ogni sistema è progettato per trasformare il tuo spazio con eleganza e praticità. Scopri le soluzioni innovative che uniscono design e funzionalità, offrendo comfort e versatilità in un unico gesto.

The result of years of technological research and trial tests on materials and patents, the mechanisms used on all our models allows you to switch from a comfortable sofa to a sofa bed instinctively and in total safety. They can be foldaway, transverse, horizontal, frontal or sliding, with overlapping beds: each model has its own type.



Rolling System mechanism



Consente di passare dalla configurazione di divano a quella di letto matrimoniale in un unico movimento, semplicemente ribaltando lo schienale e senza la rimozione delle parti imbottite. Per attivare il meccanismo e rivelare il piano di riposo è infatti sufficiente tirare la cinghia in pelle integrata

It makes it possible to change from sofa to double bed configuration in a single movement, simply by folding down the backrest and without removing the upholstered parts. To activate the mechanism and reveal the sleeping surface, simply pull the integrated leather strap.

Easy Bed System mechanism



In maniera intuitiva e in completa sicurezza, questo meccanismo consente di ottenere un piano di riposo come risultato della giustapposizione delle parti imbottite di spalliera e seduta. La prima va reclinata di 90°, mentre la seduta deve essere sollevata e fatta scorrere in avanti.

In an intuitive and completely safe way, this mechanism allows to obtain a resting surface as a result of the juxtaposition of the upholstered parts of the backrest and seat. The main must be reclined by 90°, while the seat must be raised and slid forward.

Reverse System
mechanism



Il passaggio da divano a letto avviene attivando il meccanismo a ribalta integrato, semplicemente tirando la cinghia agganciata ai cuscini di seduta e senza la necessità di rimuoverli. Il risultato sarà un piano di riposo matrimoniale, orientato trasversalmente rispetto alla seduta.

The transition from sofa to bed is made by activating the integrated folding mechanism, simply by pulling the strap attached to the seat cushions and without the need to remove them. The result will be a double sleeping surface, oriented transversally to the seat.

Duo System
mechanism



Sistema di meccaniche che consente la configurazione in due letti singoli: un primo piano di riposo corrisponde alla seduta del divano, mentre un ulteriore letto singolo, alloggiato nella base, si ottiene grazie ad un meccanismo ad estrazione e scorrimento dotato di quattro ruote per facilitarne lo spostamento. Il sollevamento del secondo letto avviene tramite un meccanismo azionabile con una leva.

Mechanics system that allows configuration into two single beds: a first sleeping surface corresponds to the seat of the sofa, while a further single bed, placed in the base, is obtained thanks to an extension and sliding mechanism equipped with four wheels for easy movement. The second bed is raised by means of a lever-operated mechanism.

Solo System
mechanism



La trasformazione da divano a letto singolo, con apertura orizzontale e materasso orientato trasversalmente rispetto alla seduta, avviene grazie ad un solo movimento: ribaltando di 180° la seduta che, nello svelare il piano di riposo, lascia in automatico scorrere e sparire nella parte sottostante la spalliera.

To convert from sofa to single bed, with horizontal opening and mattress oriented transversally compared to the seat, takes place thanks to a single movement: by tilting the seat 180°, which, while unveiling the sleeping surface, automatically lets the backrest slide and disappear underneath.

Go Up System
mechanism



Sistema brevettato di meccaniche che consente l'utilizzo di uno o due letti singoli: il primo inferiore - il cui materasso è dato dalla seduta stessa del divano - e il secondo sollevato, che configura di fatto una struttura a castello completa di scaletta e banda di protezione. Il tutto in totale sicurezza, grazie ad un collaudato sistema di blocchi con chiavi rimovibili.

A patented system of mechanics that allows the use of one or two single beds: the first lower one - whose mattress is provided by the seat of the sofa itself - and the second raised one, which effectively configures a bunk structure complete with ladder and protection strip. All in total safety, thanks to a secured and tested system of locks with removable keys.

Materassi - Mattresses

Il nostro approccio sartoriale si esprime anche attraverso la possibilità di personalizzare la tipologia di materasso, scegliendo tra diverse opzioni di altezza, densità e materiali. I materassi, che in base al modello possono essere anche sfoderabili, sono infatti proposti in diverse altezze e in tre differenti densità. Disponibili anche in memory foam o in biopolimeri da fonti rinnovabili.

Our tailoring approach is also expressed through our ability to customize mattresses, by choosing between different heights, density and materials. The mattresses, depending on the model is available with removable covers, offered in different heights and densities. Also available in memory foam or biopolymers from renewable sources.



NOTE

— I materassi per il loro impiego sono soggetti ad un normale restringimento rispetto alle misure iniziali.

— Mattresses are subject to normal wear & tear.

— Matelas sont soumis à une usure normale et retrait, du à l'utilisation.



D28

H.16 cm / H.13 cm

(standard)

Antiallergico / Anti-allergy
no CFC

Materasso Standard in poliuretano espanso HR

Il poliuretano espanso, che per la sua leggerezza e versatilità è tra i materiali più utilizzati per la realizzazione di materassi di alta qualità, si caratterizza per le sue proprietà traspiranti e di portanza grazie ad una densità di 28 kg/mc. Dal punto di vista della struttura, il poliuretano si presenta come una schiuma molto alveolata: questo conferisce al materasso una costante areazione, sinonimo di salubrità e di un sonno pulito e asciutto. Questo materasso è proposto con rivestimento trapuntato non sfoderabile in tessuto a maglia elasticizzata (Misliina).

Standard mattress in HR polyurethane

Polyurethane foam, due to its lightness and versatility is among the most widely used materials to manufacture high-quality mattresses, is characterized by its breathability and bearing capacity properties thanks to a density of 28 kg/m³ and 40 kg/m³. In terms of structure, polyurethane is a very honeycombed foam: this gives the mattress constant aeration, synonymous of wholesomeness and clean, dry sleep. This mattress is offered with a non-removable quilted cover in stretch jersey fabric (Misliina).

Materasso in biopolimeri da fonti rinnovabili

Per la realizzazione di questo materasso ci siamo avvalsi di uno dei materiali più innovativi presenti sul mercato, punto di incontro tra benessere, tecnologia e bio sostenibilità. Si tratta del Waterlily Gaia®: materiale ricavato da biopolimeri completamente atossici contenenti acqua e materie prime da fonti naturali rinnovabili, come la soia e un mix di oli essenziali di erbe officinali, note per le loro proprietà rilassanti ed emollienti. Il risultato è un materasso altamente traspirante e igienico, che favorisce la circolazione e la postura corretta. Lo proponiamo con rivestimento sfoderabile in Grafene antibatterico color bianco e fascia trapuntata di colore grigio.

Biopolymer mattress from renewable sources

To create this mattress, we used one of the most innovative materials on the market, a meeting point between wellness, technology and bio sustainability. It is the Waterlily Gaia®: a material made from completely non-toxic biopolymers containing water and raw materials from renewable natural sources, such as soya and a mix of essential oils from medicinal herbs, known for their relaxing and emollient properties. The result is a highly breathable and hygienic mattress that promotes circulation and correct posture. We offer it with a removable cover, Graphene anti-bacterial white colour, and a grey quilted band.



D45

H.16 cm / H.13 cm

(optional)

Antiallergico / Anti-allergy
no CFC



D35 Memory foam

H.16 cm / H. 13 cm

(optional)

Antiallergico / Anti-allergy
no CFC
Sfoderabile / Removable

Materasso con topper in Memory Foam e rivestimento in Grafene

Tra i materiali più dinamici esistenti, il Memory Foam si caratterizza per la sua termosensibilità e per l'alta capacità di adattarsi perfettamente alla conformazione corporea, per poi riacquisire la sua forma originale grazie all'elevata densità di 35 kg/mc. Quello che però distingue questo materasso è il rivestimento sfoderabile in tessuto color grigio stretch in esclusiva fibra di Grafene: materiale ad alta biosostenibilità, caratterizzato da proprietà batteriostatiche, termoregolatrici e antistress. Il tutto si completa con una fascia trapuntata traspirante di colore grigio.

Mattress with memory foam topper and Graphene covering

Among the most dynamic materials, Memory Foam is characterized by its thermo-sensitivity and high capacity to adapt perfectly to the body shape and then regain its original shape thanks to its high density foam of 35 kg/m³. However, what distinguishes this mattress, is the removable cover in grey stretch fabric made of exclusive Graphene fiber: a highly bio-sustainable material, characterized by bacteriostatic, thermoregulating and anti-stress properties. This is completed by a grey-colored breathable quilted band.

Reti - Mechanism

A seconda del modello di divano letto, i materassi sono collocati sulla classica rete ortopedica elettrosaldata a cinghie elastiche o, in alternativa, su rete con doghe in legno, flessibile e altamente resistente.

Our tailoring approach is also expressed through our ability to customize mattresses, by choosing between different heights, density and materials. The mattresses, depending on the model is available with removable covers, offered in different heights and densities. Also available in memory foam or biopolymers from renewable sources.



Rete con doghe

Integrata in un meccanismo con apertura sincronizzata mediante ribaltamento della spalliera, la rete costituisce un piano letto ortopedico con doghe larghe e cinghie elastiche sulla seduta. Realizzata su base in acciaio, presenta doghe in legno di faggio verniciato con polveri epossidiche di colore grigio metallizzato.

Mechanisms with wooden slats

Integrated in a mechanism with synchronized opening by tilting the backrest, the bed base constitutes an orthopedic bed platform with wide slats and elasticated webbings on the seat. Made on a steel base, it has beechwood slats painted with metallic grey epoxy powders.



Reti elettrosaldate

Il passaggio alla configurazione letto attraverso un meccanismo con apertura sincronizzata mediante ribaltamento della spalliera svela un piano di riposo ortopedico, con rete elettrosaldata e cinghie elastiche sulla seduta. La rete è realizzata in acciaio e verniciata con polveri epossidiche di colore grigio metallizzato.

Electrowelded wire mechanism

The transition to the bed configuration through a mechanism with synchronized opening by tilting the backrest reveals an orthopedic sleeping surface with an electro welded bed base and elasticated webbings on the seat. The bed base is made of steel and painted with metallic grey epoxy powders.

Apertura divani letto - How to open the sofabed



- Con una mano tirare con cautela la maniglia collocata tra i due cuscini dello schienale.
- With one hand pull the handle located between the 2 back cushions



- Con l'altra mano afferrare la parte posteriore dello schienale.
- With the other hand grab the back part of the backrest.



- Con tutte e due le mani accompagnare l'apertura della rete afferrando i componenti metallici sino ad avvenuta apertura.
- Use gently both hands to open the bed mechanism by grabbing the metal components until full opening.



- Accompagnare delicatamente l'apertura della rete letto.
- Gently guide the opening of the bed mechanism



- Assicurarsi che la fase di apertura sia terminata
- Make sure the opening phase is completed



Attenzione - Attention

- Non tirare SOLO la maniglia per aprire la rete letto, utilizzare sempre entrambe le mani.
- Do not pull only the handle to open the sofabed, always use both hands.

NOTE

- Qualora siano presenti poggiatesta reclinabili, prima di aprire la rete letto, verificare che rimangano bloccati in posizione verticale e non ritornino in posizione orizzontale.
- If there are reclining headrests, before opening the bed mechanism, make sure they are locked in the vertical position and do not return in the horizontal position.

Finiture - Finishes

Gross grain colors

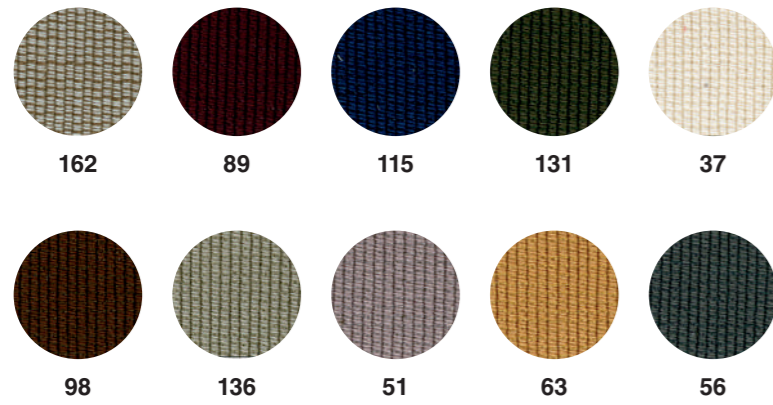

Metallo — Metal — Metal

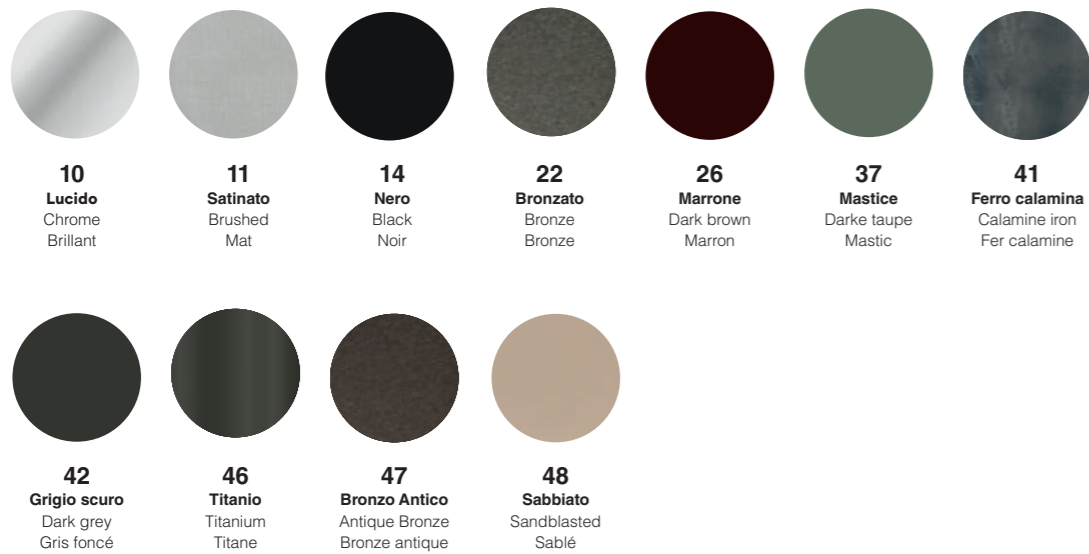

Legno — Wood — Bois



I riferimenti dei colori qui riportati sono da considerarsi puramente indicativi.

Color reference shown is only indicative.

La référence coloris mentionnée est purement indicative.



the sofabed collection by Maxdivani s.r.l.

Largo Epitaffio, 1
70022 Altamura (BA) Italy
Tel / Fax +39 080 9266200
info@sartorisitalia.it
p.iva 08059830722

www.sartorisitalia.it

Alcuni dei complementi utilizzati nel presente catalogo fanno parte della collezione Maxdivani, consultabile sul sito www.maxdivani.it.

stampato in Italia a Maggio 2025
printend in Italy - May 2025

La MAXDIVANI s.r.l. si riserva la facoltà di modificare in qualunque momento e senza preavviso, le caratteristiche tecniche degli elementi usati nel presente catalogo. Le misure riportate nei grafici possono subire variazioni dovute alla manifattura. Alcuni accessori presenti nelle immagini fotografiche non sono prodotti dalla MAXDIVANI s.r.l.. Il presente catalogo è tutelato dalla legge sui diritti d'Autore (legge 22.4.1941, n° 633 e della legge 14.12.1942, n° 1485): e successive modifiche, di esso è proibita ogni riproduzione, totale o anche parziale in Italia o all'estero.

MAXDIVANI s.r.l. reserves the right to modify in any moment and without notice the technical characteristics of the elements used in this catalogue. Some dimensions reported in the schematics may be subject to modifications due to manufacturing. Some of the accessories shown in the pictures are not produced by MAXDIVANI s.r.l.. This catalogue is protected by the law on Author's Rights (law dated 22.04.1941, no. 633 and by the law dated 14.12.1942, no. 1485): and its following modifications. Any reproduction, complete or in part, is forbidden in Italy and abroad.

MAXDIVANI s.r.l. se réserve le droit de modifier à tout moment et sans préavis les caractéristiques techniques des éléments utilisés dans ce catalogue. Les mesures montrées dans les graphiques peuvent subir des variations dues à la fabrication. Certains accessoires présents dans les images photographiques ne sont pas produits par MAXDIVANI srl Ce catalogue est protégé par la loi sur les droits d'auteur (loi 22.4.1941, loi n° 633 et loi 14.12.1942, n° 1485): telle que modifiée, Il est interdit toute reproduction, totale ou même partielle en Italie ou à l'étranger.

El MAXDIVANI s.r.l. se reserva el derecho de modificar en cualquier momento y sin previo aviso las características técnicas de los elementos utilizados en este catálogo. Las medidas que se muestran en los gráficos pueden sufrir variaciones debido a la fabricación. Algunos accesorios presentes en las imágenes fotográficas no son producidos por MAXDIVANI s.r.l. Este catálogo está protegido por la ley de derechos de autor (ley 22.4.1941, n° 633 y ley 14.12.1942, n° 1485): está prohibido cualquier reproducción, total o parcial en Italia o en el extranjero.